

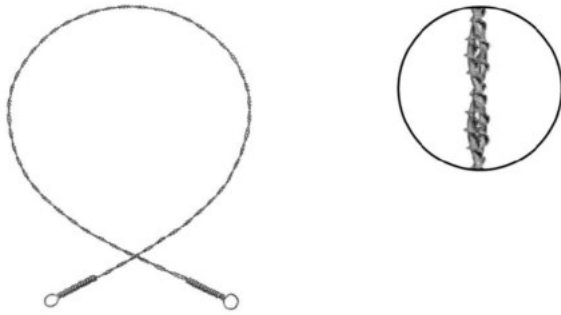

Neurology Sugery



GIGLI
Saws

▶ 038-0101	30.0cm, 12"
038-0102	40.0cm, 16"
038-0103	50.0cm, 20"



Gigli Saw
Handle

▶ 038-0109



DE MARTEL
Gigli Saw Conductor

▶ 038-0108 | 33.0cm, 13"



DE VILBISS
Cranial Rongeur
▶ 038-0201 | 20.5cm, 8"

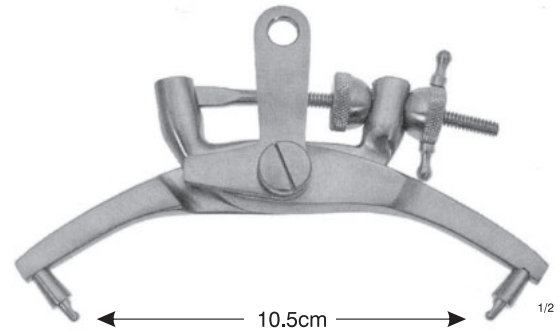

CRUTCHFIELD
Skull Traction
▶ 038-0210

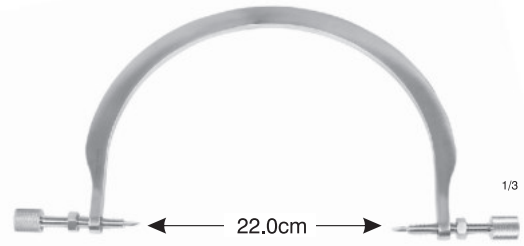

HEAD TRACTION
▶ 038-0220 | 22.0cm, 8 1/2"



RANEY
038-0300 | 16.0cm, 6 1/4"

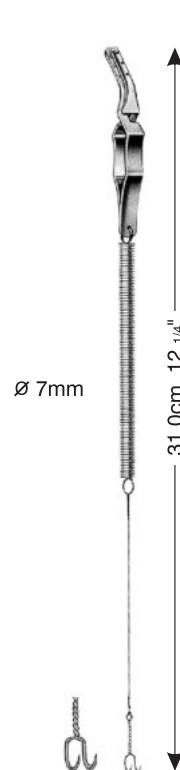

YASARGIL
Galea Hook
017-3701

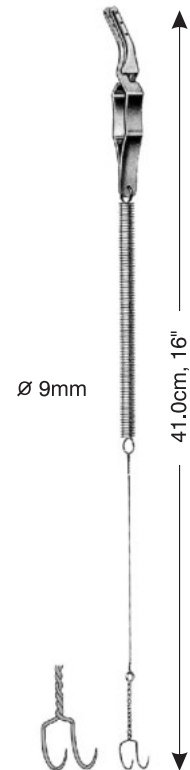

YASARGIL
Galea Hook
▶ 017-3702



CUSHING-LANDOLT
Specula for Trans-sphenoidal
Hypophysectomy

038-0401	70x15mm
038-0402	90x15mm
038-0403	110x15mm



PAPAVERO-CASPAR
Specula for Trans-sphenoidal
Hypophysectomy

038-0404	80x11mm
038-0405	90x13mm
038-0406	100x15mm



LANDOLT
Spreader for Specula

038-0500	21.0cm, 8 1/4"
-----------------	----------------

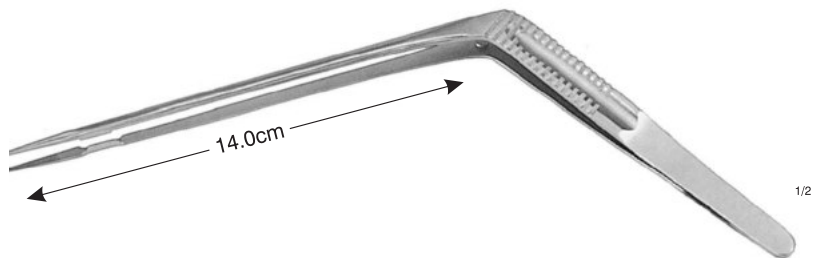

LANDOLT
Forceps

038-0600	21.0cm, 8 1/4"
-----------------	----------------

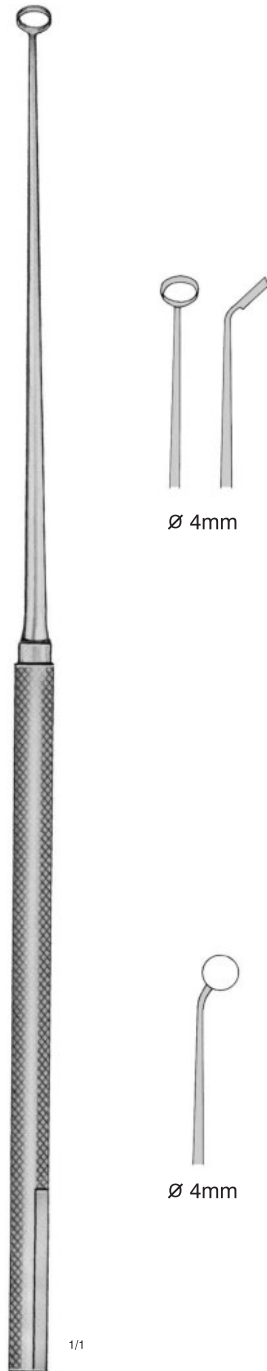

038-0701 | Horizontal 45°

038-0702 | Vertical 45°

RAY
Curettes
18.0cm, 7"

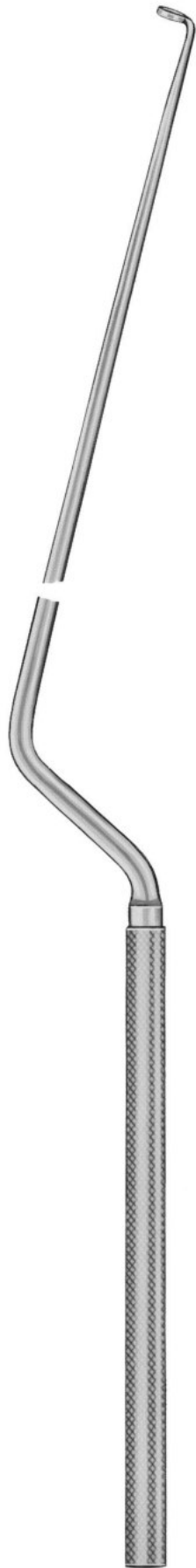

HARDY
Curettes
26cm, 10 1/4"



Ø 4mm

038-0703 | Malleable



Ø 6mm

038-0704 | Malleable

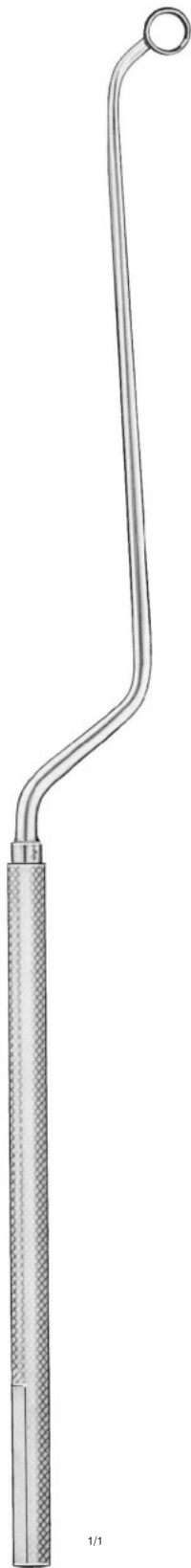

NICOLA
Currettes
21.5cm, 8 1/2"



Ø 6.5mm

038-0705 | Malleable, Cutting to the Right



Ø 6.5mm

038-0706 | Malleable, Cutting to the Left



Ø 6.5mm

038-0707 | Malleable

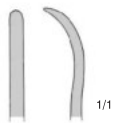

1/1

038-0801 | Raspatory



YASARGIL
18.5cm, 7 1/4"

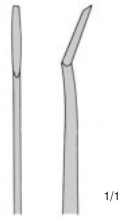

038-0804 | 18.5cm, 7 1/4"

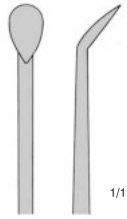

038-0805 | 18.5cm, 7 1/4"

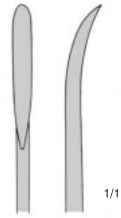

038-0806 | 18.5cm, 7 1/4"

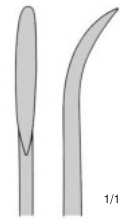

038-0807 | 18.5cm, 7 1/4"

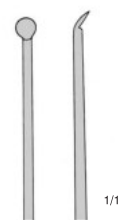

038-0808 | 23.0cm, 9"

Round Blade

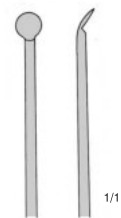

038-0809 | 23.0cm, 9"

Round Blade



YASARGIL
18.5cm, 7 1/4"

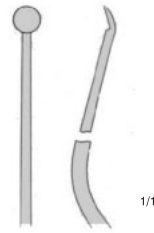

038-0810 | 23.0cm, 9"

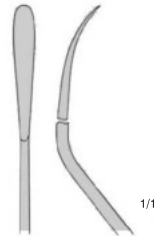

038-0811 | 18.5cm, 7 1/4"

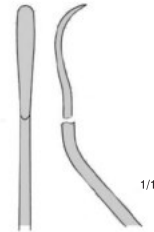

038-0812 | 18.5cm, 7 1/4"

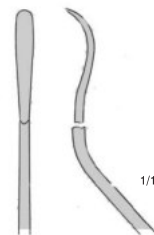

038-0813 | 18.5cm, 7 1/4"



HARDY
24.5cm, 9 1/4"



HARDY
Enucleator
Blunt

038-0901 Right
038-0911 Left



HARDY
Enucleator
Blunt

038-0902 Right
038-0912 Left



HARDY
Enucleator
Sharp

038-0903 Right
038-0913 Left



HARDY
Enucleator
Sharp

038-0904 Right
038-0914 Left



HARDY
Implant Fork

038-1001



HARDY-FAHLBUSCH
Dissector Sharpened
inner edge

038-1101



HARDY-FAHLBUSCH
Dissector Sharpened
inner edge

038-1102



LANDOLT
26.0cm, 10 1/4"



LANDOLT
Enucleator
Blunt
Malleable

038-0905	Right
038-0915	Left



LANDOLT
Enucleator
Blunt
Malleable

038-0906	Right
038-0916	Left

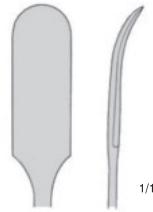

LANDOLT
Curette
Malleable

038-0708

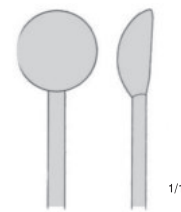

LANDOLT
Scoop
Malleable

038-1201



LANDOLT
Blunt Hook
Malleable

038-1301



HOSOBUCHI
Fork Spatula
Rigid

038-1002



1/1

FAHLBUSCH
26.0cm, 10 1/4"



1/1

FAHLBUSCH
Scoop
Malleable

038-1202



Ø 2.5mm

FAHLBUSCH
Curette
Malleable

038-0709



Ø 2.2mm

LANDOLT-REULEN
Raspatory
Rigid

038-0802



Ø 3.2mm

LANDOLT-REULEN
Raspatory
Rigid

038-0803



Ø 2.5mm

LANDOLT-REULEN
Curette
Rigid

038-0710



1.7mm

LANDOLT-REULEN
Blunt Hook
Rigid

038-1302



2.0mm

LANDOLT-REULEN
Dissector
Rigid

038-1103



JACOBSON
Micro Vessel Knife

038-1401 | 18.5cm, 7 1/4"



1/1



JACOBSON
Vessel Knife

038-1402 | 9.5cm, 3 3/4"



1/1



Handle with Chuck
10.5cm, 4"

038-1700 | Only Handle

1/1



Hook

038-1303 | 8.5cm, 3 3/8"

1/1

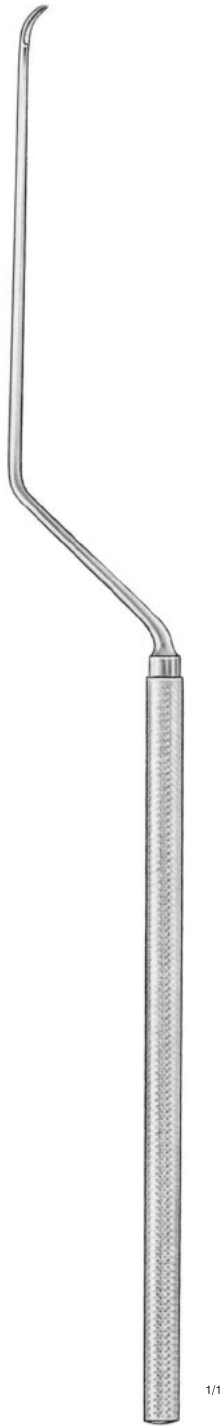

KOOS
18.5cm, 7 1/4"

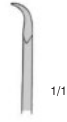

1/1

KOOS

038-1403

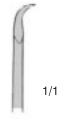

1/1

KOOS

038-1404



1/1

KOOS

038-1405

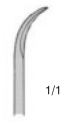

1/1

KOOS

038-1406



1/1

KOOS

038-1407



1/1

KOOS

038-1408



1/1

YASARGIL

038-1409



1/1

YASARGIL

038-1410



SAMII
20.0cm, 8"



1.0mm



1.5mm



2.0mm



2.5mm



3.0mm



3.5mm



4.0mm



5.0mm

038-1501	20.0cm, 8"	1.0mm	038-1521	23.0cm, 9"	1.0mm
038-1502	20.0cm, 8"	1.5mm	038-1522	23.0cm, 9"	1.5mm
038-1503	20.0cm, 8"	2.0mm	038-1523	23.0cm, 9"	2.0mm
038-1504	20.0cm, 8"	2.5mm	038-1524	23.0cm, 9"	2.5mm
038-1505	20.0cm, 8"	3.0mm	038-1525	23.0cm, 9"	3.0mm
038-1506	20.0cm, 8"	3.5mm	038-1526	23.0cm, 9"	3.5mm
038-1507	20.0cm, 8"	4.0mm	038-1527	23.0cm, 9"	4.0mm
038-1508	20.0cm, 8"	5.0mm	038-1528	23.0cm, 9"	5.0mm



SAMII
23.0cm, 9"



Ø 1.5mm

- | | |
|-----------------|------------|
| 038-1509 | 20.0cm, 8" |
| 038-1529 | 23.0cm, 9" |

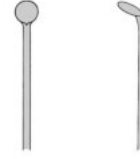

Ø 3.0mm

- | | |
|-----------------|------------|
| 038-1510 | 20.0cm, 8" |
| 038-1530 | 23.0cm, 9" |

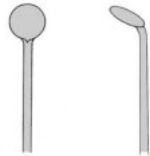

Ø 4.5mm

- | | |
|-----------------|------------|
| 038-1511 | 20.0cm, 8" |
| 038-1531 | 23.0cm, 9" |

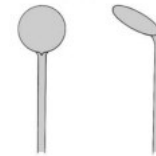

Ø 6.0mm

- | | |
|-----------------|------------|
| 038-1512 | 20.0cm, 8" |
| 038-1532 | 23.0cm, 9" |

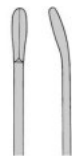

1.8mm
Lancet Knives

- | | |
|-----------------|------------|
| 038-1601 | 23.0cm, 9" |
|-----------------|------------|



2.5mm
Lancet Knives

- | | |
|-----------------|------------|
| 038-1602 | 23.0cm, 9" |
|-----------------|------------|



OKONEK-YASARGIL
23.0cm, 9"



3.0mm

038-1010



4.0mm

038-1020



5.0mm

038-1030



8.0mm

038-1040



CASPAR
23.0cm, 9"



CASPAR
4.5mm

038-1104 | 23.0cm, 9"



CASPAR
1.0mm

038-1105 | 20.0cm, 8"



038-1106 | 23.0cm, 9"



038-1107 | 23.0cm, 9"



038-1108 | 23.0cm, 9"



3.0mm

038-1109 | 18.5cm, 7 1/4"



3.0mm

038-1110 | 21.5cm, 8 1/2"



YASARGIL

038-1111 | 18.5cm, 7 1/4"

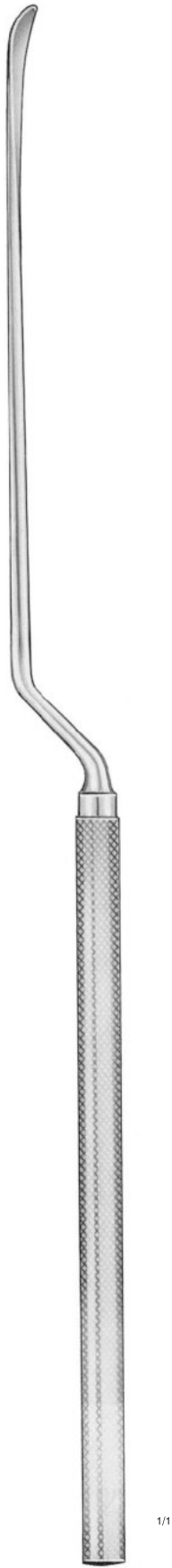

CASPAR
23.0cm, 9"

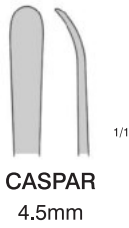

038-1112 | 23.0cm, 9"

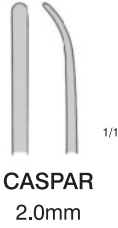

038-1113 | 23.0cm, 9"

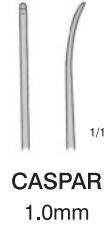

038-1114 | 21.0cm, 8 1/4"

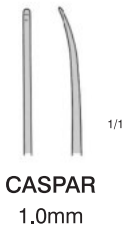

038-1115 | 21.0cm, 8 1/4"

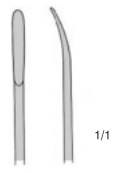

038-1116 | 23.0cm, 9"

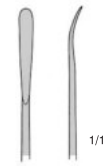

038-1117 | 23.0cm, 9"

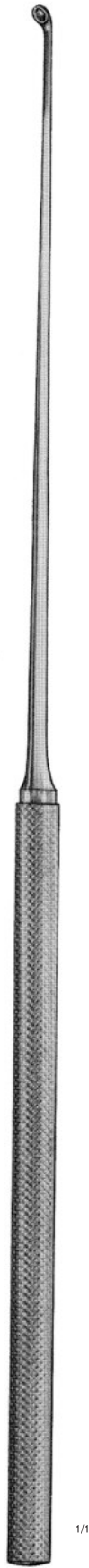

23.0cm, 9"

1/1



Straight

1/1

038-1203 | 23.0cm, 9"

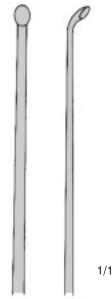

Curved up

1/1

038-1204 | 23.0cm, 9"

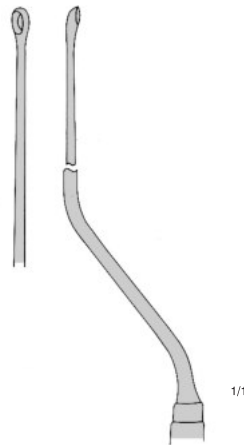

YASARGIL

038-1205 | 18.5cm, 7 1/4"

1/1



23.0cm, 9"



Sharp

038-1304 | 23.0cm, 9"



Blunt

038-1305 | 23.0cm, 9"



Sharp, Curved

038-1306 | 18.5cm, 7 1/4"



FISCH
Sharp, Angled

038-1307 | 18.5cm, 7 1/4"



BIEMER
16.0cm, 6 1/4"



BIEMER
Vessel Spreader

038-1801 | 16.0cm, 6 1/4"



Vessel Dilator
Ø 0.5mm

038-1802 | 12.5cm, 5"



Vessel Dilator
Ø 1.0mm

038-1803 | 12.5cm, 5"



Vessel Dilator
Ø 1.5mm

038-1804 | 12.5cm, 5"



JACOBSON
Probe with Ball Tip

038-1805 | 18.5cm, 7 1/4"



JACOBSON
Vessel Probe

038-1806 | 18.5cm, 7 1/4"

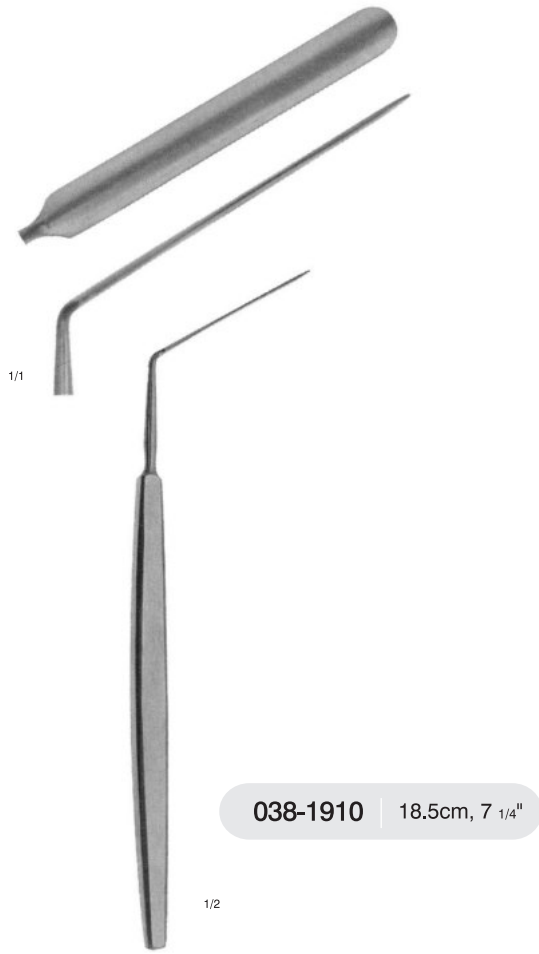

038-1910 | 18.5cm, 7 1/4"

HORSLEY



038-1920 | 23.0cm, 9"

SACHS

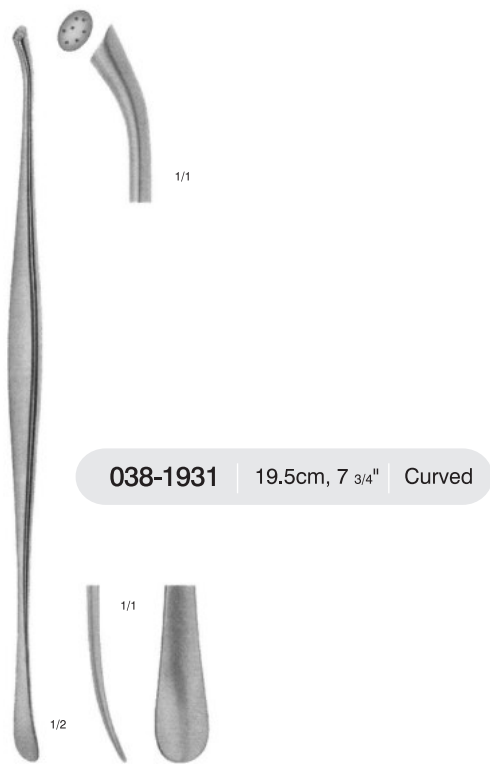

038-1931 | 19.5cm, 7 3/4" | Curved

PENFIELD

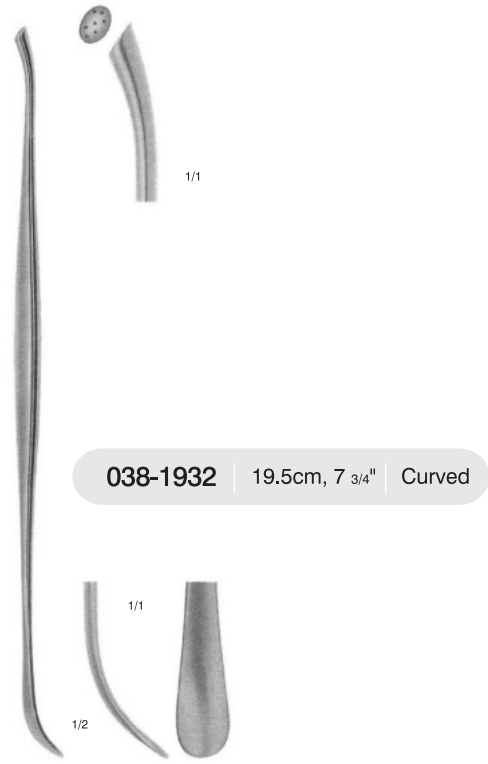

038-1932 | 19.5cm, 7 3/4" | Curved

PENFIELD

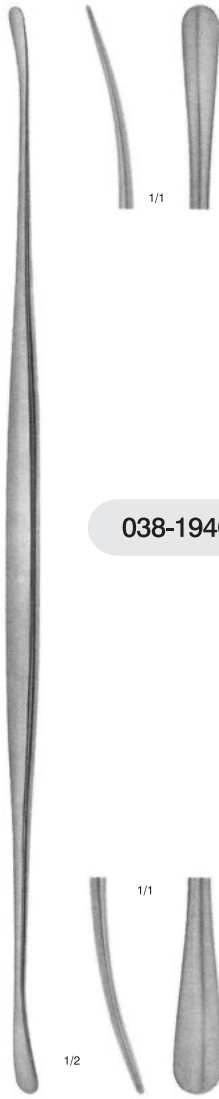

038-1940 | 29.0cm, 11 2/5"

PENFIELD

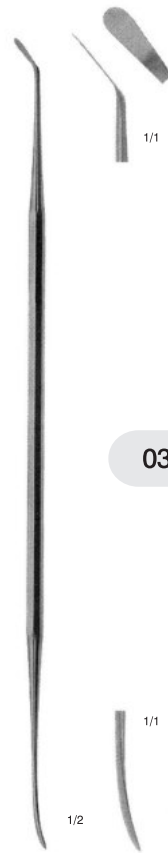

038-1950 | 21.0cm, 8 1/4"

MILLIGAN

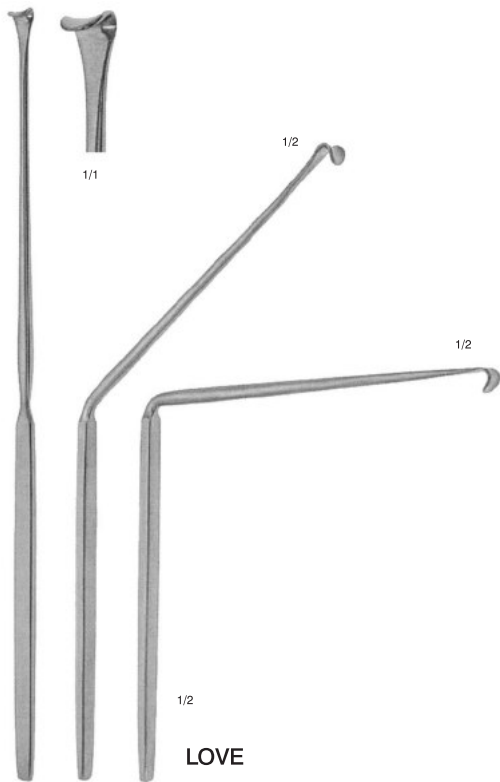

- ▶ 015-3001 22.0cm, 8 1/2" Straight
- ▶ 015-3002 22.0cm, 8 1/2" 45° Angled
- ▶ 015-3003 22.0cm, 8 1/2" 90° Angled



▶ 015-6701 | 20.0cm, 8"

CUSHING



▶ 015-3201 | 23.0cm, 9" | Straight

SCOVILLE



▶ 015-3211 | 22.0cm, 8 1/2" | Curved

SCOVILLE



ROOT

015-3300 | 23.0cm, 9" | 6mm Blade



DURA

- | | | |
|----------|------------|--------|
| 015-3101 | 18.0cm, 7" | 3x10mm |
| 015-3102 | 18.0cm, 7" | 4x10mm |
| 015-3103 | 18.0cm, 7" | 5x10mm |
| 015-3104 | 18.0cm, 7" | 7x10mm |

6.2mm



D'ERRICO

▶ 015-3500 | 23.0cm, 9" | Bayonet Style

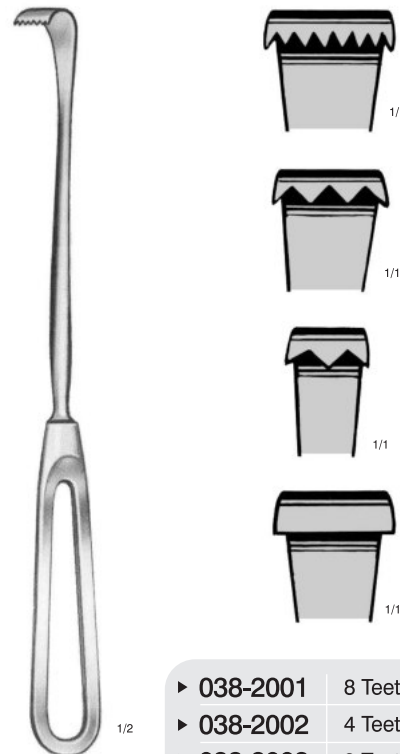

OLDBERG
20.0cm, 8"

- | | |
|------------|------------------|
| ▶ 038-2001 | 8 Teeth on Blade |
| ▶ 038-2002 | 4 Teeth on Blade |
| ▶ 038-2003 | 3 Teeth on Blade |
| ▶ 038-2004 | Flat Blade |

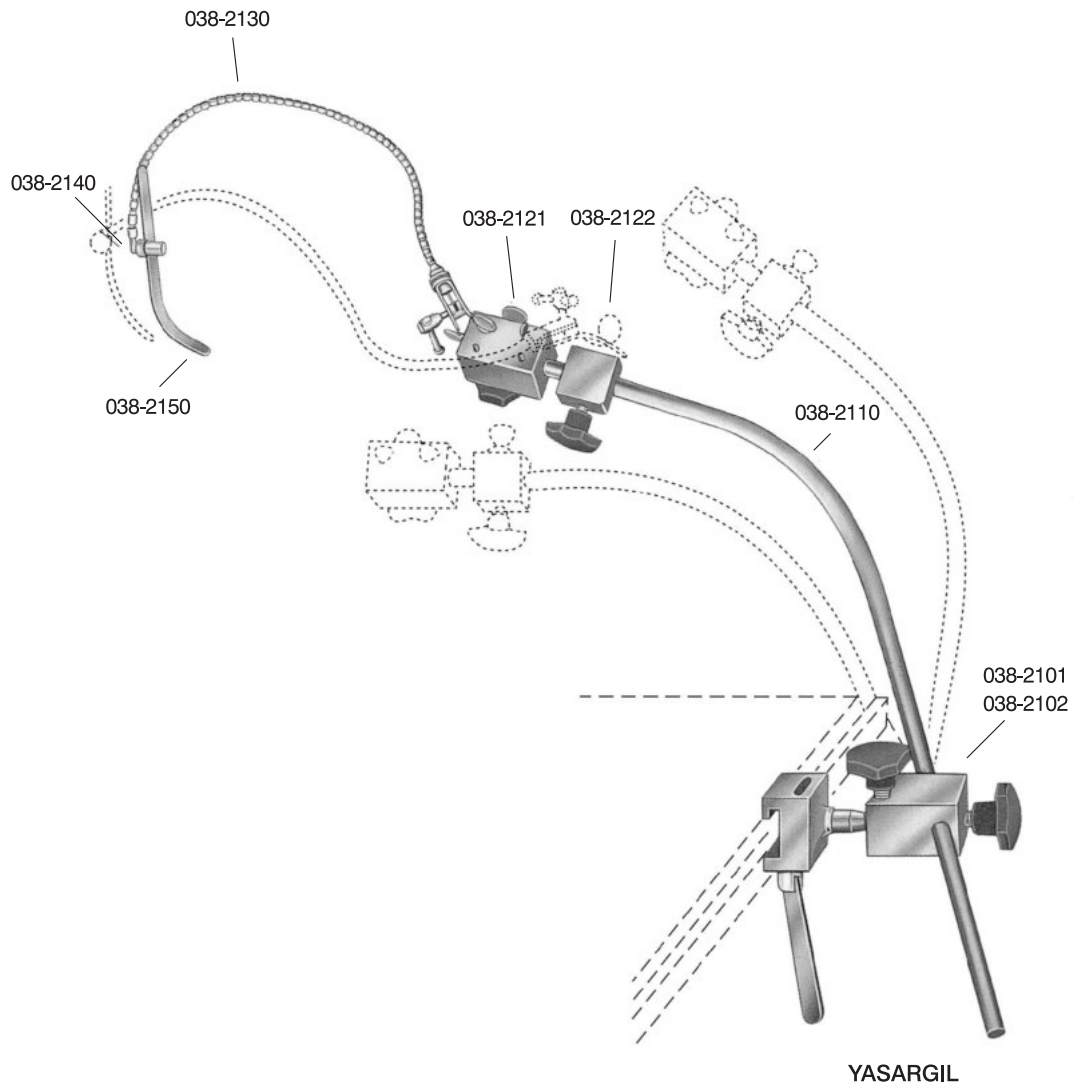

038-2101	Ball and socket joint for fixation on operating table 10x25mm, alternative to 038-2102
038-2102	Ball and socket joint for fixation on operating table 9x32mm, alternative to 038-2101
038-2110	Holding rod for fixation
038-2121	Coupling head for 5 flexible arms max.
038-2122	Coupling head, turnable, alternative to 038-2121
038-2123	Coupling head, laterally open, alternative to 038-2121
038-2130	Flexible arm
038-2140	Holder for flat brain spatula
038-2150	Brain spatula



YASARGIL

038-2103 Brain retractor, flexible, for flat spatula, with 1 flexible arm, complete.

Consist of : 038-2144 Fixation base for 1 flexible arm
038-2130 Flexible arm only
038-2140 Support for flat brain spatulas

038-2104 Brain retractor, flexible, for flat spatula, with 2 flexible arms, complete.

Consist of : 038-2142 Fixation base for 2 flexible arms
038-2130 Flexible arm only (2X)
038-2140 Support for flat brain spatulas (2X)

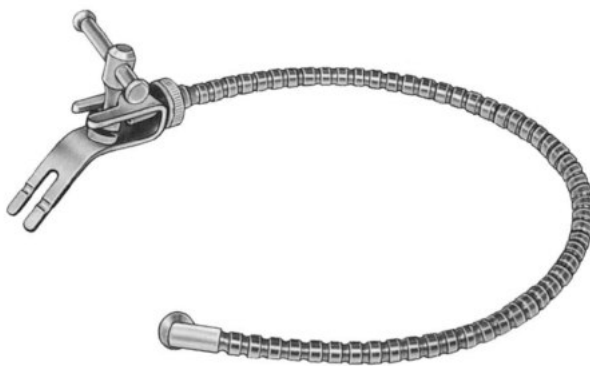

YASARGIL

038-2130 Flexible arm only

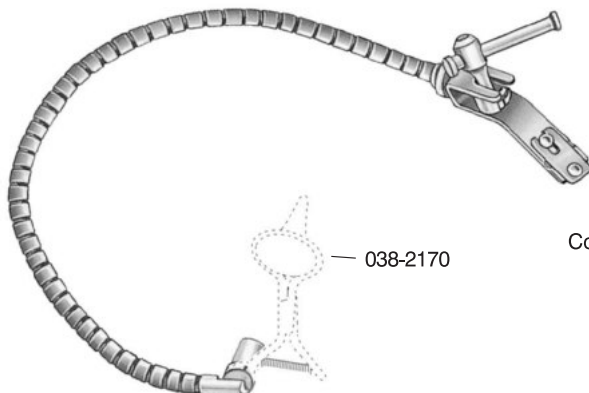

YASARGIL

038-2105 Ear specula holder complete

Consist of : 038-2130 Flexible arm only
038-2144 Clamp for fixation on bar up to Ø16mm
038-2170 Ear specula holder only

— 038-2170



038-2140 Support for flat brain spatula

038-2141 Support for brain spatula with round shaft



038-2142 Fixation for 2 arms at skull

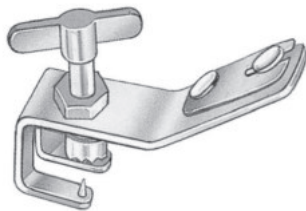

038-2143 Fixation for 1 arm at skull

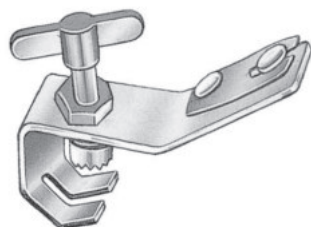

038-2144 Fixation base for 1 arm on bar up to Ø16mm



Malleable
20.0cm, 8"

038-2151	14mm
038-2152	17mm
038-2153	20mm



HEIFETZ
Malleable
15.5cm, 6 1/8"

038-2181	8mm
038-2182	11mm
038-2183	14mm
038-2184	17mm



CUSHING

038-2157	18.0cm, 7"	7x9mm
038-2158	20.0cm, 8"	11x13mm
038-2159	28.0cm, 11"	15x18mm



▶ 038-2190		SET	
▶ 038-2191	42.0cm, 16 1/2"	Holding Rod for Fixation	Fig.1
▶ 038-2192	21.3cm, 8 2/5"	Holding Rod for Fixation	Fig.2
▶ 038-2193	21.3cm, 8 2/5"	Fixation on Operating Table	Fig.3
▶ 038-2131	33.0cm, 13"	Flexible arm	Fig.4
▶ 038-2185	15.0cm, 6"	Brain Spatula 14.0mm	Fig.5
▶ 038-2186	15.0cm, 6"	Brain Spatula 8.0mm	Fig.6
▶ 038-2187	15.0cm, 6"	Brain Spatula 11.0mm	Fig.7
▶ 038-2188	15.0cm, 6"	Brain Spatula 3.0mm Teeth	Fig.8

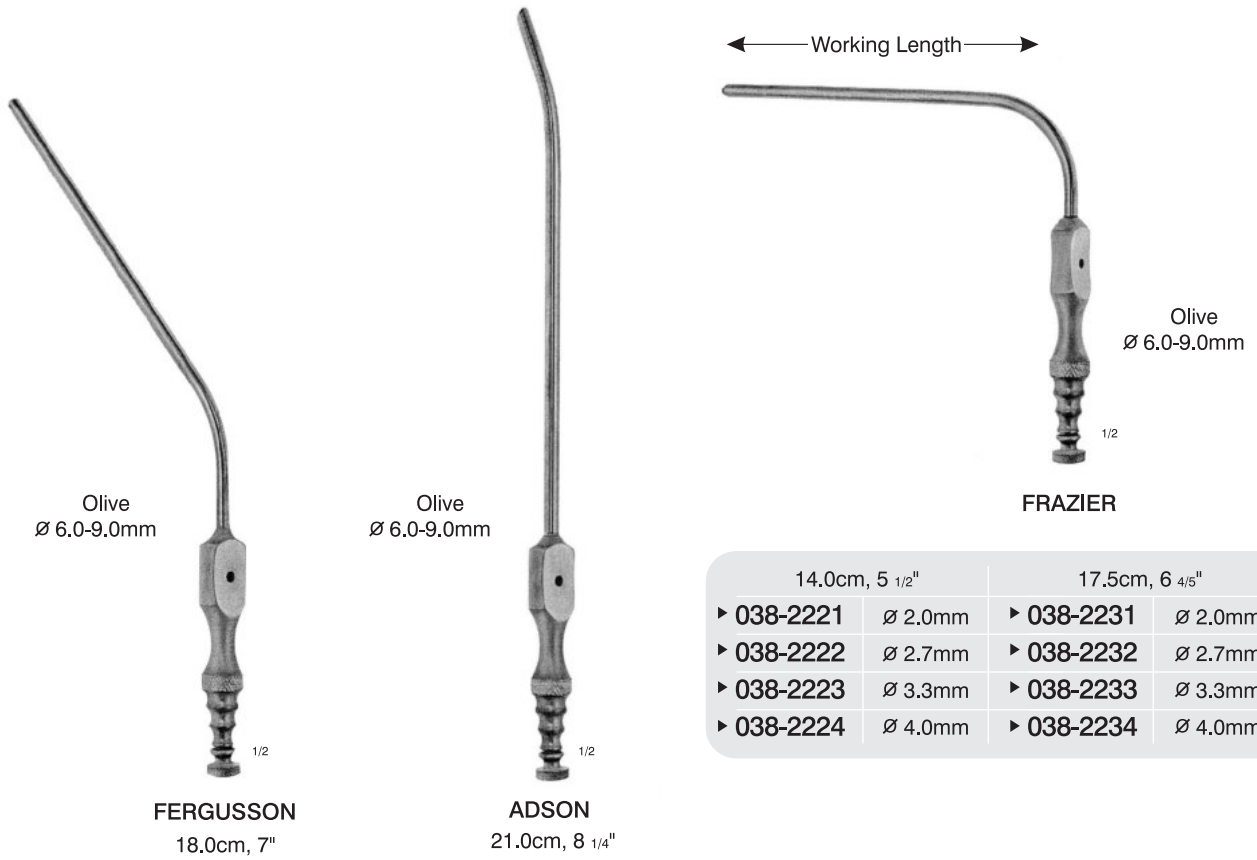

- ▶ 038-2201 | Ø 2.0mm
- ▶ 038-2202 | Ø 2.5mm
- ▶ 038-2203 | Ø 3.0mm
- ▶ 038-2204 | Ø 4.0mm
- ▶ 038-2205 | Ø 5.0mm

- ▶ 038-2210 | Ø 4.0mm

14.0cm, 5 1/2"		17.5cm, 6 4/5"	
▶ 038-2221	Ø 2.0mm	▶ 038-2231	Ø 2.0mm
▶ 038-2222	Ø 2.7mm	▶ 038-2232	Ø 2.7mm
▶ 038-2223	Ø 3.3mm	▶ 038-2233	Ø 3.3mm
▶ 038-2224	Ø 4.0mm	▶ 038-2234	Ø 4.0mm



- 038-2251 | Ø 2.0mm
- 038-2252 | Ø 2.5mm
- 038-2253 | Ø 3.0mm

25.0cm, 10"

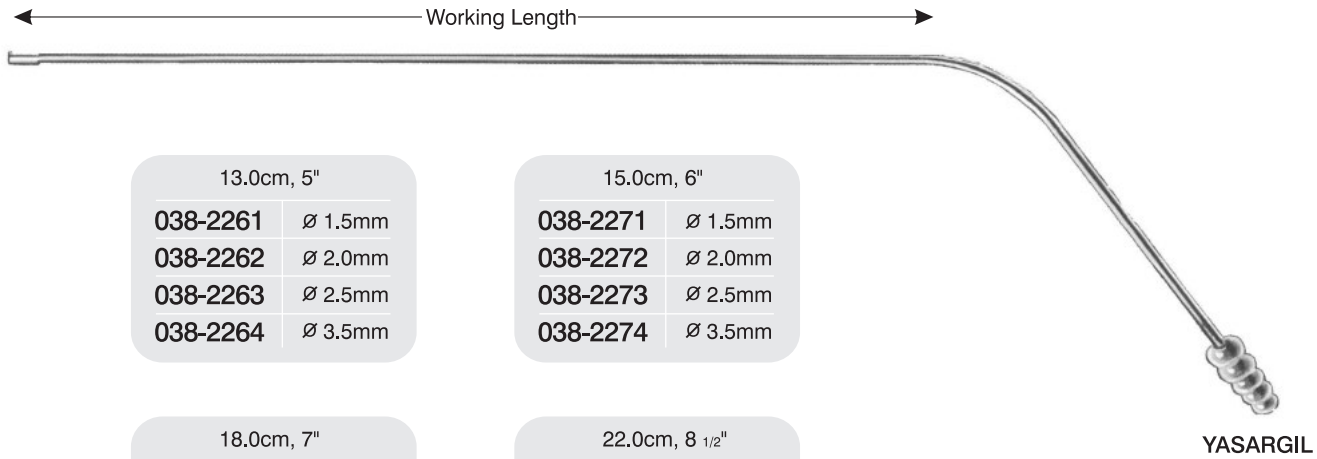

13.0cm, 5"

038-2261	Ø 1.5mm
038-2262	Ø 2.0mm
038-2263	Ø 2.5mm
038-2264	Ø 3.5mm

15.0cm, 6"

038-2271	Ø 1.5mm
038-2272	Ø 2.0mm
038-2273	Ø 2.5mm
038-2274	Ø 3.5mm

18.0cm, 7"

038-2281	Ø 1.5mm
038-2282	Ø 2.0mm
038-2283	Ø 2.5mm
038-2284	Ø 3.5mm
038-2285	Ø 4.5mm

22.0cm, 8 1/2"

038-2291	Ø 1.5mm
038-2292	Ø 2.0mm
038-2293	Ø 2.5mm
038-2294	Ø 3.5mm

YASARGIL

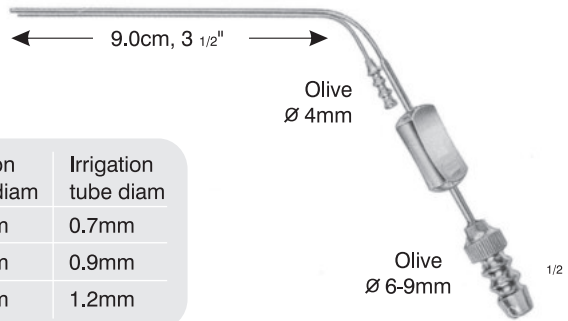

	Suction tube diam	Irrigation tube diam
038-2301	0.9mm	0.7mm
038-2302	1.2mm	0.9mm
038-2303	1.5mm	1.2mm

HOUSE
Suction Irrigation

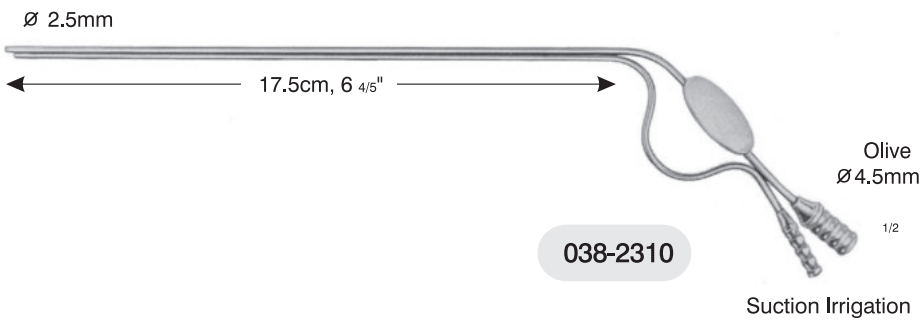

038-2310

Suction Irrigation

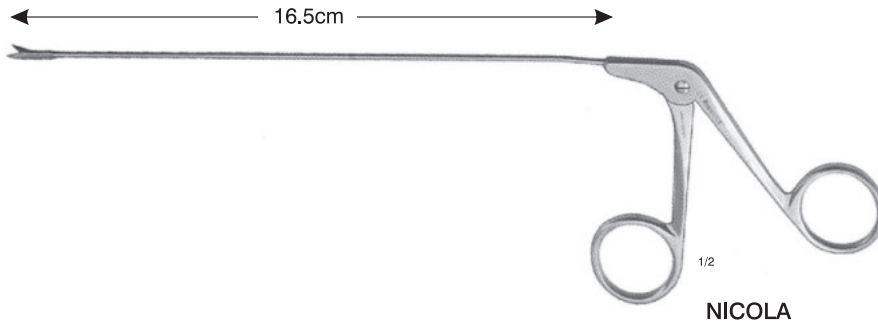

FAHLBUSCH
Micro Scissors, horizontal cutting

038-2401



NICOLA
Forceps scoop-shaped

038-2410

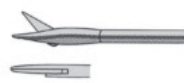

NICOLA
Forceps Scissors, straight

038-2402

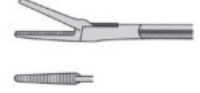

YASARGIL-NICOLA
Forceps

038-2420

Laminectomy Punches

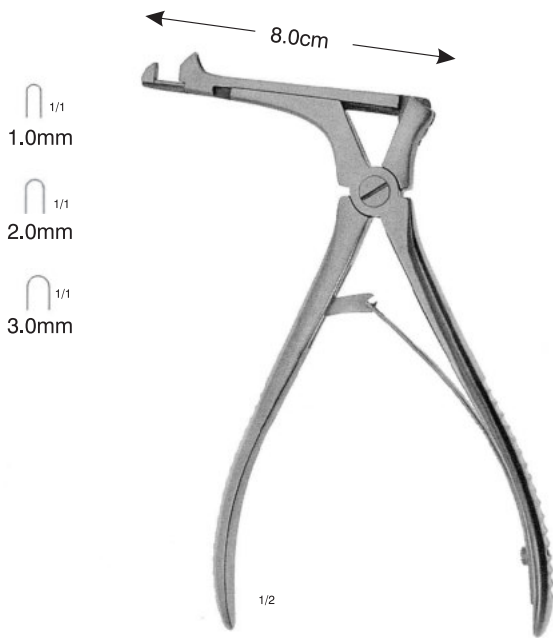

CITELLY

- 038-2501 1.0mm
- ▶ 038-2502 2.0mm
- 038-2503 3.0mm

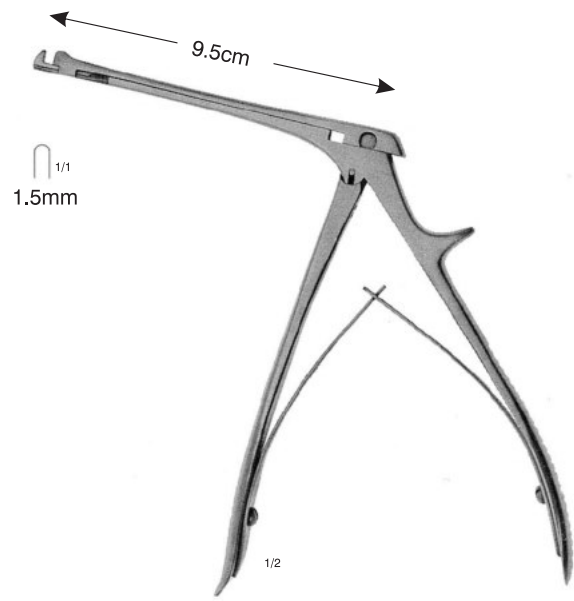

BEYER

038-2510



- ▶ 038-2601 | 3.0mm
- ▶ 038-2602 | 4.0mm
- ▶ 038-2603 | 5.0mm
- ▶ 038-2604 | 6.0mm



KERRISON
Upwards cutting 90°

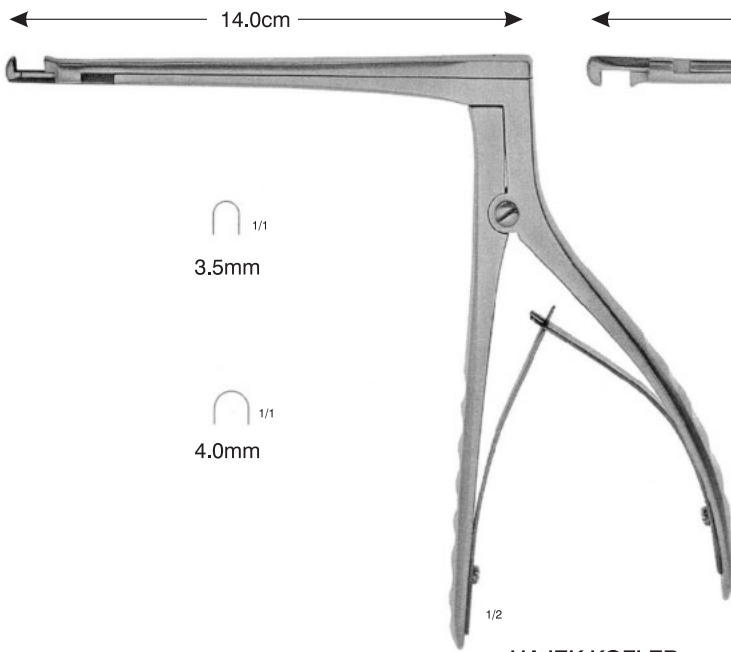

HAJEK-KOFLER
Upwards cutting 90°

- 038-2701 | 3.5mm
- 038-2702 | 4.0mm

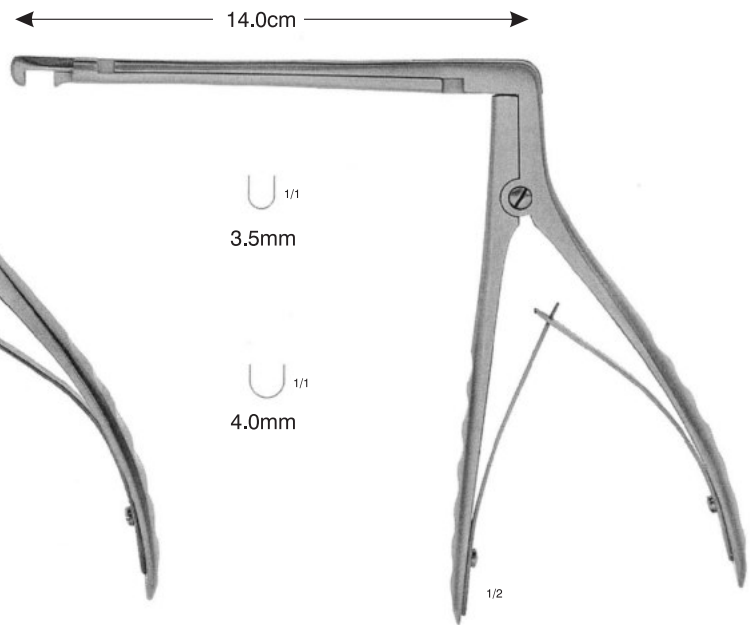

HAJEK-KOFLER
Downwards cutting 90°

- 038-2711 | 3.5mm
- 038-2712 | 4.0mm

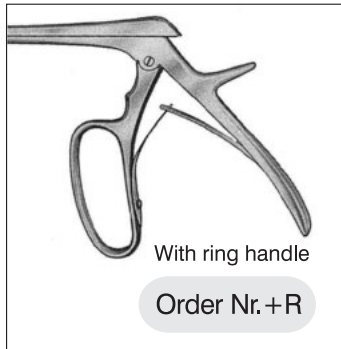
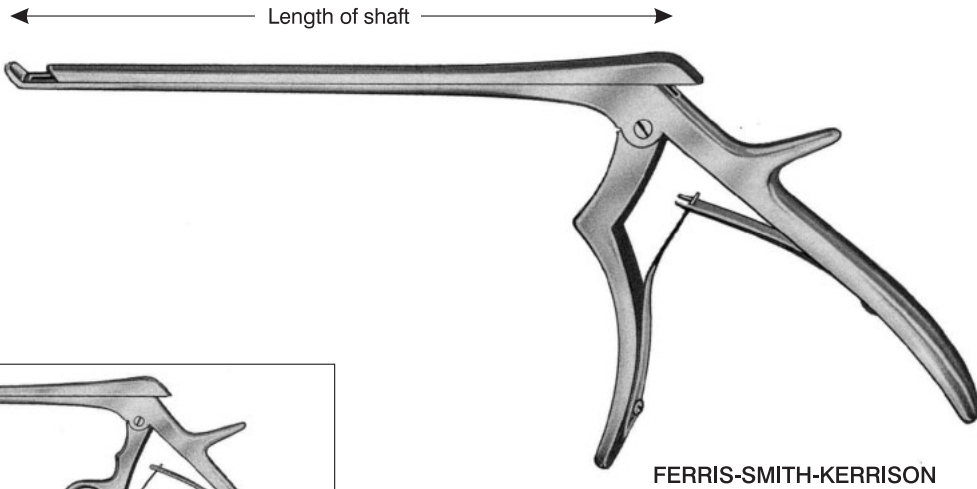

90° Upwards cutting

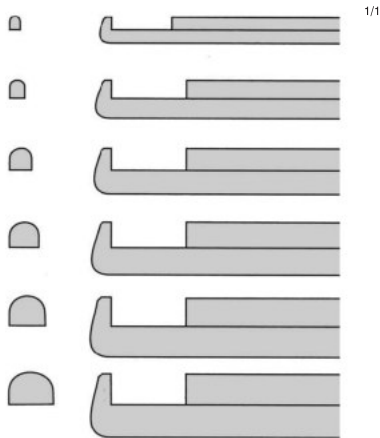





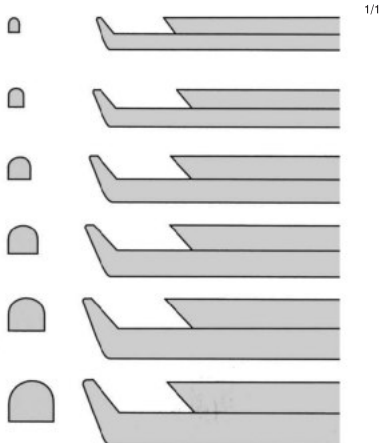



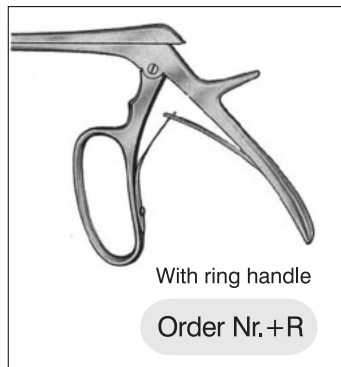
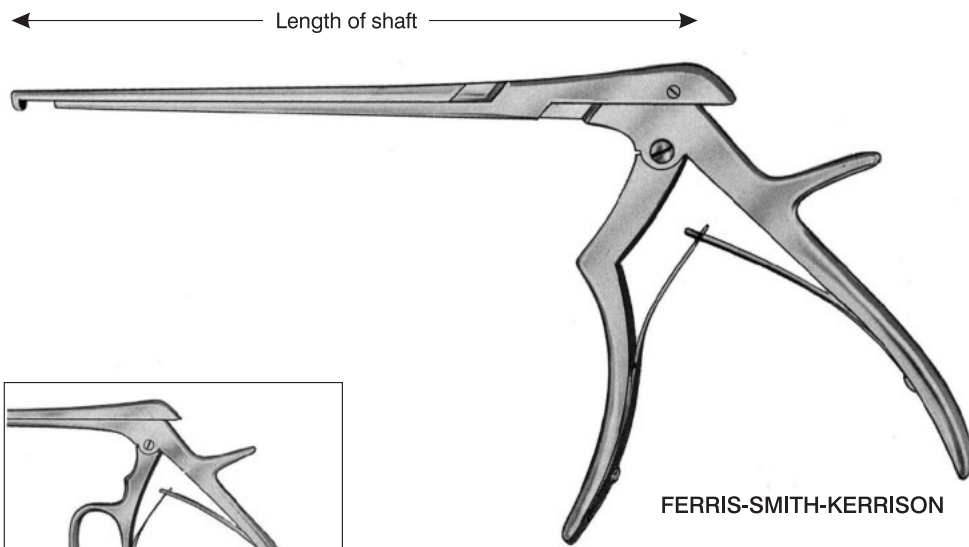



	Length of shaft		
	15.2cm, 6"	18.0cm, 7"	20.3cm, 8"
1mm	038-2801	038-2811	038-2821
2mm	038-2802	038-2812	▶ 038-2822
3mm	038-2803	038-2813	▶ 038-2823
4mm	038-2804	038-2814	▶ 038-2824
5mm	038-2805	038-2815	▶ 038-2825
6mm	038-2806	038-2816	▶ 038-2826





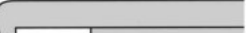



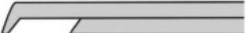

40° Upwards cutting

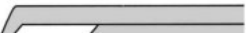

	Length of shaft		
	15.2cm, 6"	18.0cm, 7"	20.3cm, 8"
1mm	038-2901	038-2911	038-2921
2mm	038-2902	038-2912	▶ 038-2922
3mm	038-2903	038-2913	▶ 038-2923
4mm	038-2904	038-2914	▶ 038-2924
5mm	038-2905	038-2915	▶ 038-2925
6mm	038-2906	038-2916	▶ 038-2926



		Length of shaft	
		18.0cm, 7"	20.3cm, 8"
90° Downwards cutting	  ^{1/1}	1mm	038-3011 038-3021
	 	2mm	038-3012 038-3022
	 	3mm	038-3013 ▶ 038-3023
	 	4mm	038-3014 ▶ 038-3024
	 	5mm	038-3015 ▶ 038-3025
	 	6mm	038-3016 ▶ 038-3026

		Length of shaft	
		18.0cm, 7"	20.3cm, 8"
40° Downwards cutting	  ^{1/1}	1mm	038-3111 038-3121
	 	2mm	038-3112 038-3122
	 	3mm	038-3113 038-3123
	 	4mm	038-3114 038-3124
	 	5mm	038-3115 038-3125
	 	6mm	038-3116 038-3126

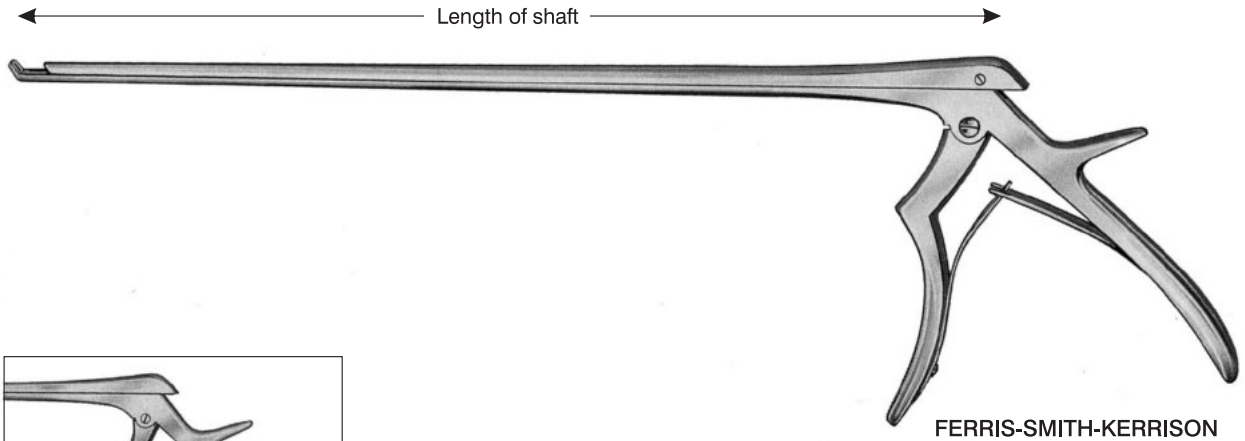

FERRIS-SMITH-KERRISON

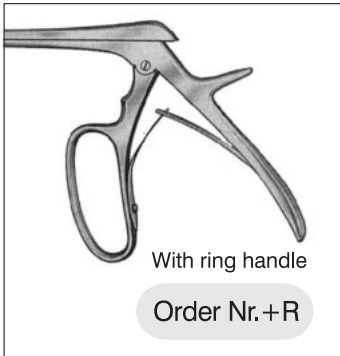

90° Upwards cutting

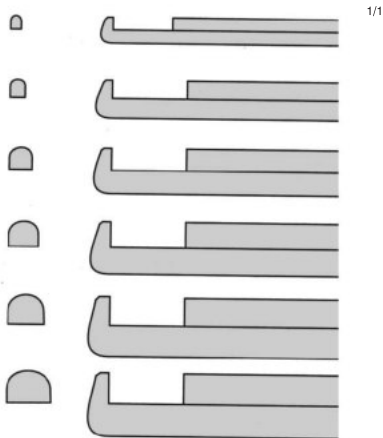

	Length of shaft		
	27.9cm, 11"	30.5cm, 12"	33.0cm, 13"
1mm	038-3201	038-3211	038-3221
2mm	038-3202	038-3212	038-3222
3mm	038-3203	038-3213	038-3223
4mm	038-3204	038-3214	038-3224
5mm	038-3205	038-3215	038-3225
6mm	038-3206	038-3216	038-3226

40° Upwards cutting

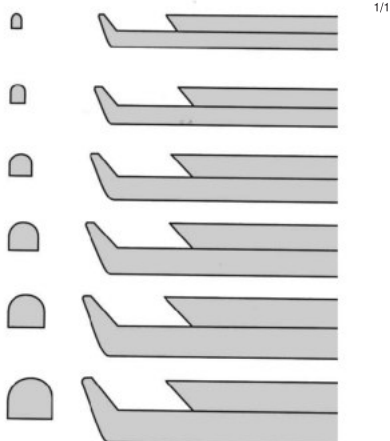

	Length of shaft		
	27.9cm, 11"	30.5cm, 12"	33.0cm, 13"
1mm	038-3301	038-3311	038-3321
2mm	038-3302	038-3312	038-3322
3mm	038-3303	038-3313	038-3323
4mm	038-3304	038-3314	038-3324
5mm	038-3305	038-3315	038-3325
6mm	038-3306	038-3316	038-3326

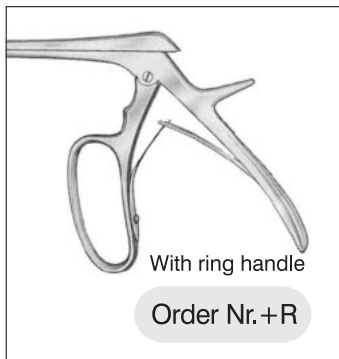
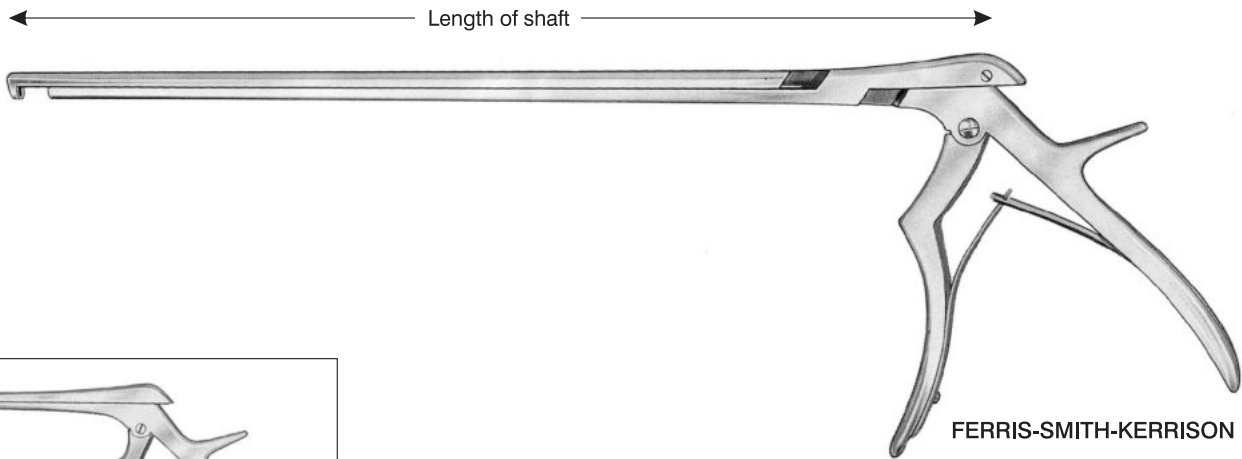

		Length of shaft		
		27.9cm, 11"	30.5cm, 12"	33.0cm, 13"
90° Downwards cutting	1mm	038-3401	038-3411	038-3421
	2mm	038-3402	038-3412	038-3422
	3mm	038-3403	038-3413	038-3423
	4mm	038-3404	038-3414	038-3424
	5mm	038-3405	038-3415	038-3425
	6mm	038-3406	038-3416	038-3426
40° Downwards cutting	1mm	038-3501	038-3511	038-3521
	2mm	038-3502	038-3512	038-3522
	3mm	038-3503	038-3513	038-3523
	4mm	038-3504	038-3514	038-3524
	5mm	038-3505	038-3515	038-3525
	6mm	038-3506	038-3516	038-3526

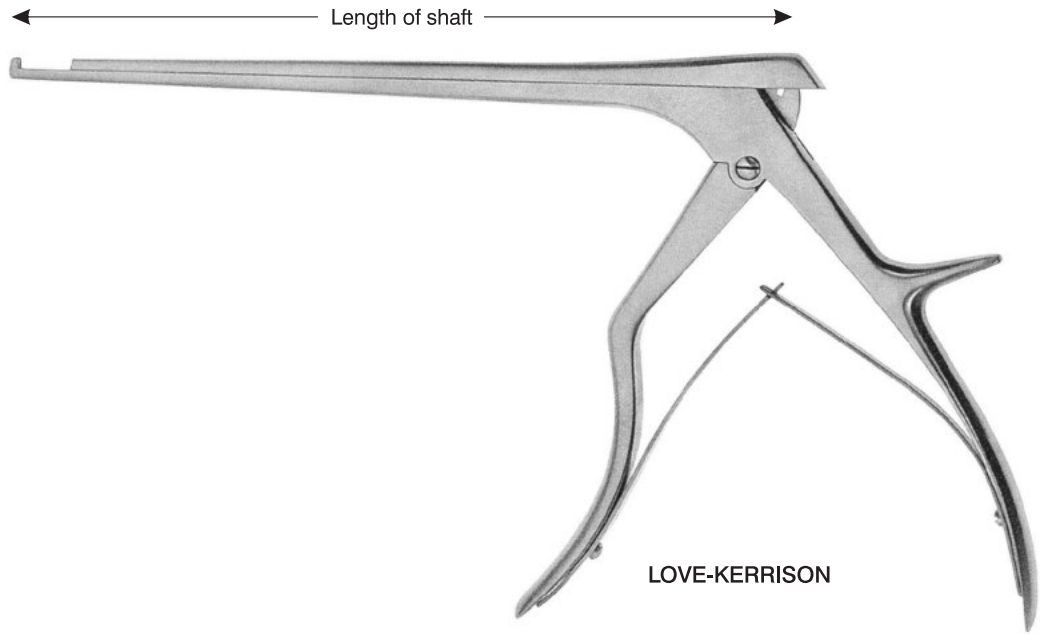

			Length of shaft			
			15.0cm, 6"	18.0cm, 7"	20.0cm, 8"	
90° Upwards cutting			2mm	038-3602	038-3612	038-3622
			3mm	038-3603	038-3613	038-3623
			4mm	038-3604	038-3614	038-3624
			5mm	038-3605	038-3615	038-3625
			6mm	038-3606	038-3616	038-3626
90° Downwards cutting			2mm	038-3702	038-3712	038-3722
			3mm	038-3703	038-3713	038-3723
			4mm	038-3704	038-3714	038-3724
			5mm	038-3705	038-3715	038-3725
			6mm	038-3706	038-3716	038-3726
40° Upwards cutting			2mm	038-3802	038-3812	038-3822
			3mm	038-3803	038-3813	038-3823
			4mm	038-3804	038-3814	038-3824
			5mm	038-3805	038-3815	038-3825
			6mm	038-3806	038-3816	038-3826

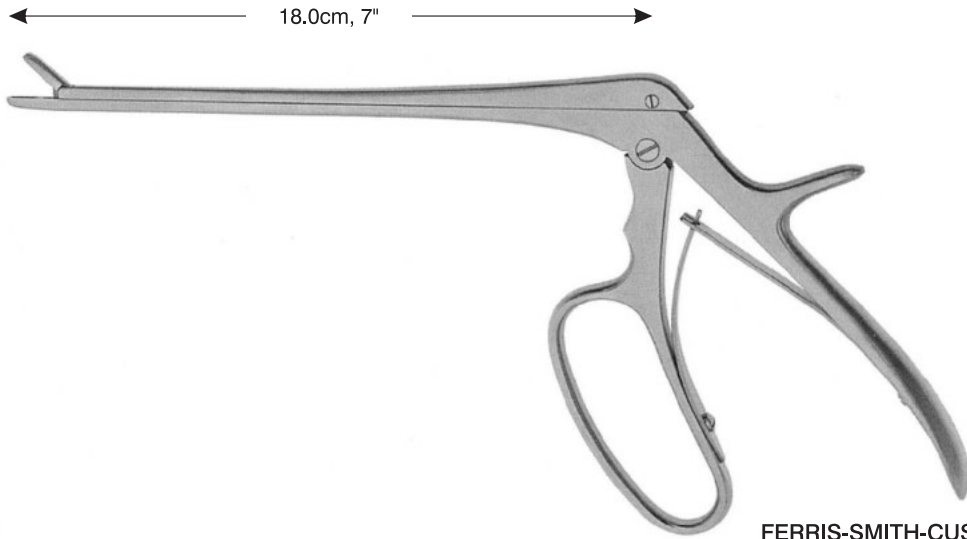

FERRIS-SMITH-CUSHING

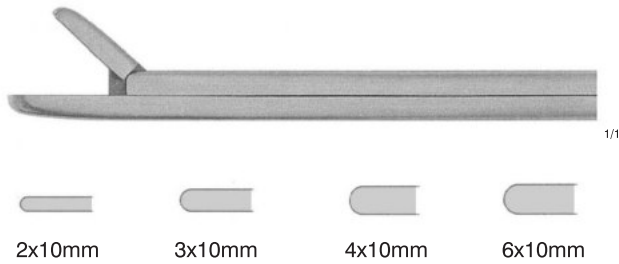

2x10mm 3x10mm 4x10mm 6x10mm

038-3902 038-3903 038-3904 038-3906

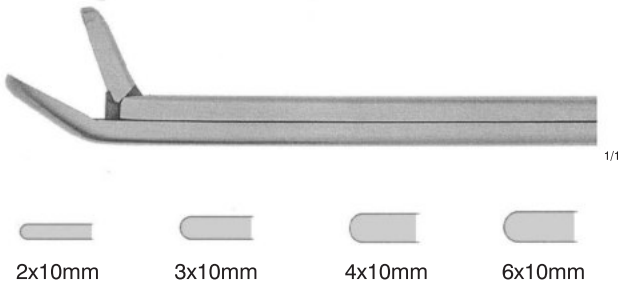

2x10mm 3x10mm 4x10mm 6x10mm

038-3912 038-3913 038-3914 038-3916

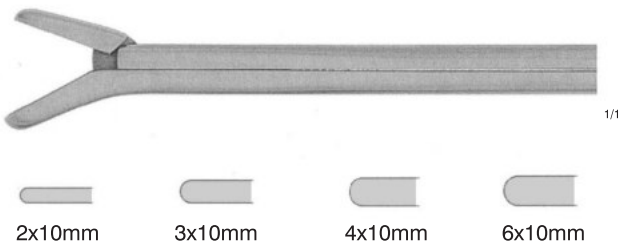

2x10mm 3x10mm 4x10mm 6x10mm

038-3922 038-3923 038-3924 038-3926

- 038-4001 3.0mm
- 038-4002 3.6mm
- 038-4003 4.2mm
- 038-4004 4.8mm
- 038-4005 5.8mm

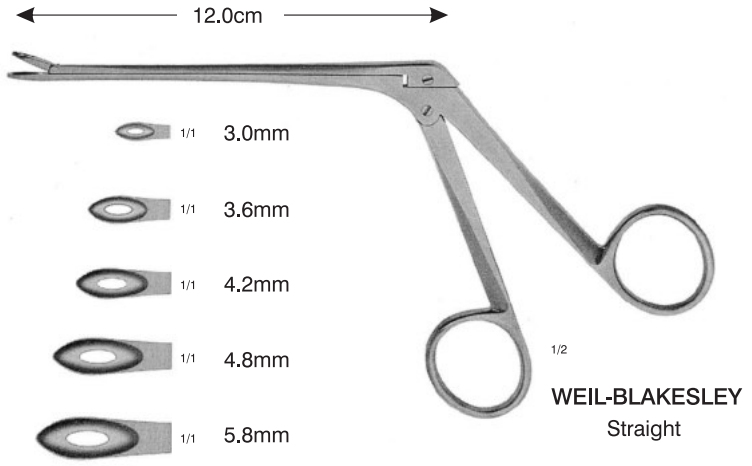

- 038-4012 3.6mm
- 038-4013 4.2mm
- 038-4014 4.8mm

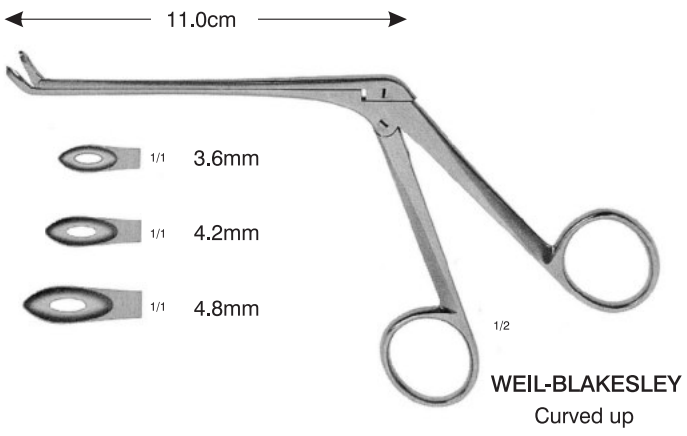

- 038-4101 3.0mm

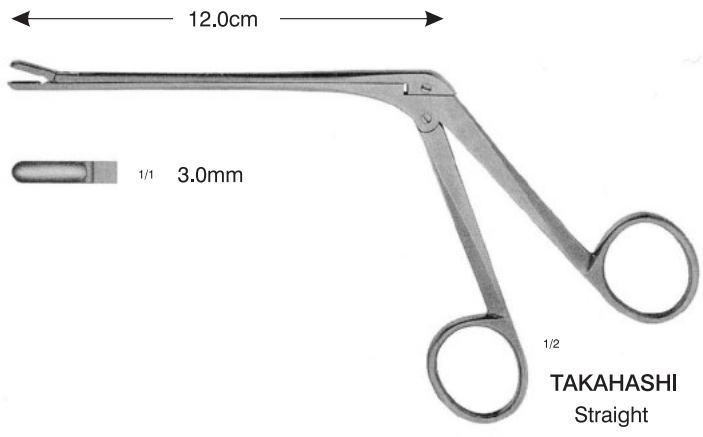



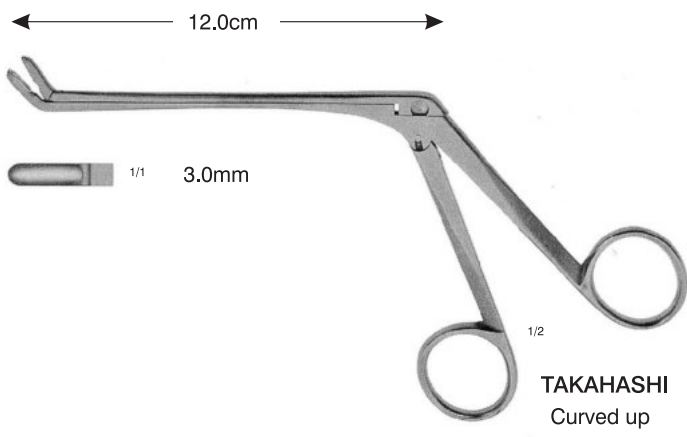

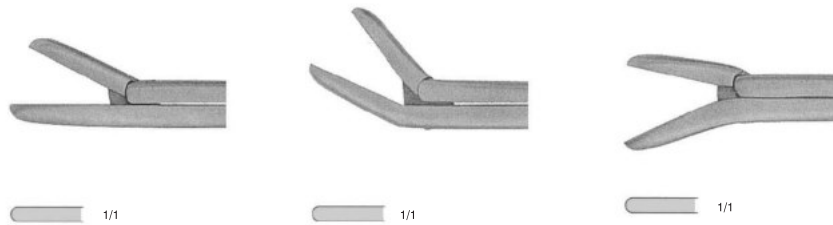
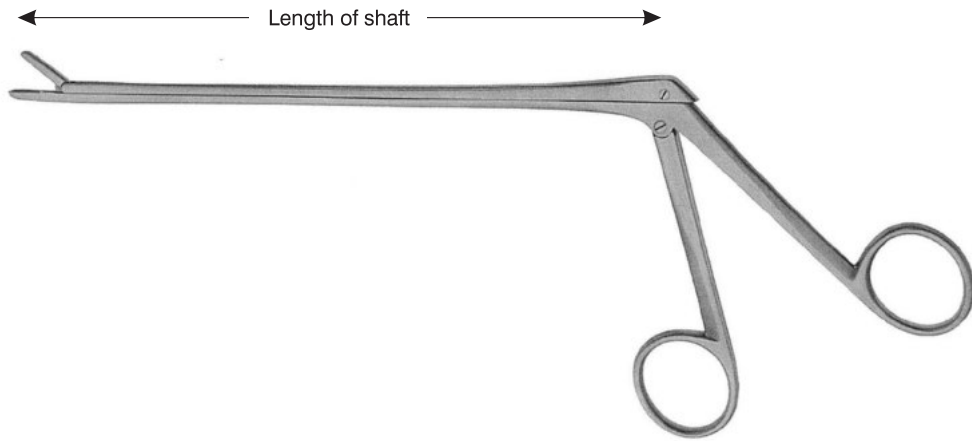

- 038-4111 3.0mm

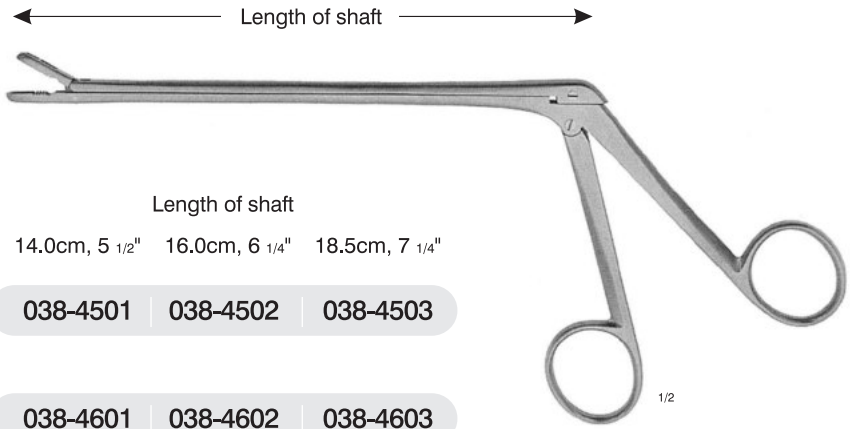









	Cushing 2x10mm	Cushing 2x10mm	Cushing 2x10mm
Length of shaft			
12.0cm, 4 3/4"	▶ 038-4201	▶ 038-4211	▶ 038-4221
15.0cm, 6"	▶ 038-4202	▶ 038-4212	▶ 038-4222
18.0cm, 7"	▶ 038-4203	▶ 038-4213	▶ 038-4223
	Love-Gruenwald 3x10mm	Love-Gruenwald 3x10mm	Love-Gruenwald 3x10mm
Length of shaft			
12.0cm, 4 3/4"	▶ 038-4301	▶ 038-4311	▶ 038-4321
15.0cm, 6"	▶ 038-4302	▶ 038-4312	▶ 038-4322
18.0cm, 7"	▶ 038-4303	▶ 038-4313	▶ 038-4323
	Spurling 4x10mm	Spurling 4x10mm	Spurling 4x10mm
Length of shaft			
12.0cm, 4 3/4"	▶ 038-4401	▶ 038-4411	▶ 038-4421
15.0cm, 6"	▶ 038-4402	▶ 038-4412	▶ 038-4422
18.0cm, 7"	▶ 038-4403	▶ 038-4413	▶ 038-4423

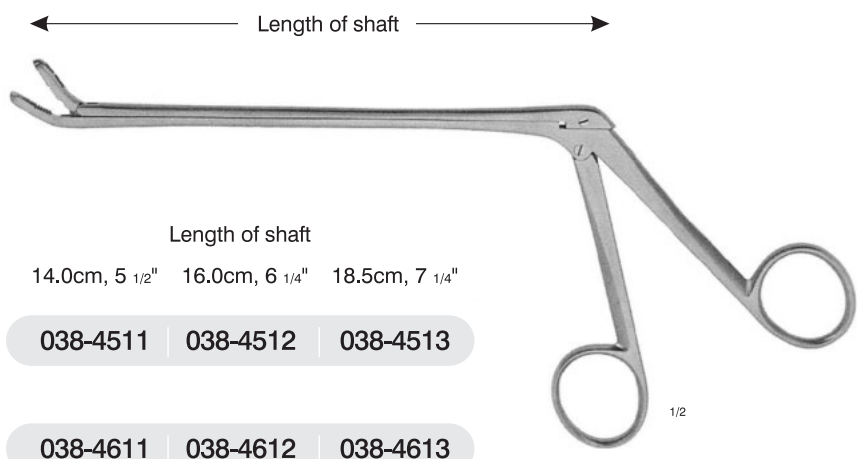

		Length of shaft			
		14.0cm, 5 1/2"	16.0cm, 6 1/4"	18.5cm, 7 1/4"	
	1/1	2x12mm	038-4501	038-4502	038-4503
	1/1	3x12mm	038-4601	038-4602	038-4603
	1/1	4x14mm	038-4701	038-4702	038-4703
	1/1	5x14mm	038-4801	038-4802	038-4803
	1/1	6x16mm	038-4901	038-4902	038-4903

CASPAR
Serrated and fenestrated jaws





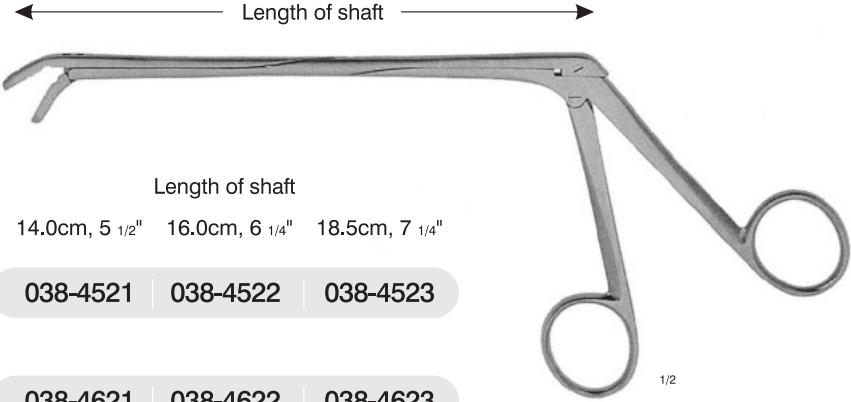

		Length of shaft			
		14.0cm, 5 1/2"	16.0cm, 6 1/4"	18.5cm, 7 1/4"	
	1/1	2x12mm	038-4511	038-4512	038-4513
	1/1	3x12mm	038-4611	038-4612	038-4613
	1/1	4x14mm	038-4711	038-4712	038-4713
	1/1	5x14mm	038-4811	038-4812	038-4813
	1/1	6x16mm	038-4911	038-4912	038-4913

CASPAR
Serrated and fenestrated jaws



← Length of shaft →



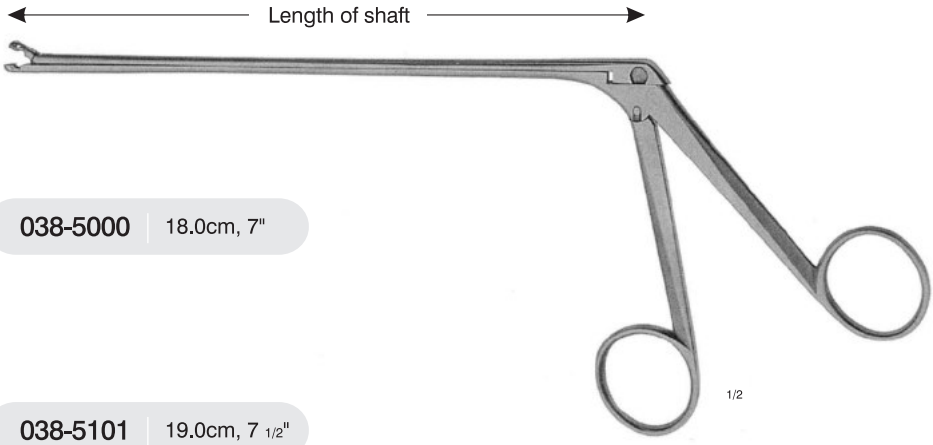

Length of shaft
14.0cm, 5 1/2" 16.0cm, 6 1/4" 18.5cm, 7 1/4"

	1/1	2x12mm	038-4521	038-4522	038-4523
	1/1	3x12mm	038-4621	038-4622	038-4623
	1/1	4x14mm	038-4721	038-4722	038-4723
	1/1	5x14mm	038-4821	038-4822	038-4823
	1/1	6x16mm	038-4921	038-4922	038-4923

CASPAR
Serrated and fenestrated jaws



← Length of shaft →

	OLDBERG Sharp Pituitary Rongeur Ø 7.0mm	038-5000	18.0cm, 7"
	LANDOLT Sharp Pituitary Rongeur Ø 2.2mm	038-5101	19.0cm, 7 1/2"
	YASARGIL Sharp Pituitary Rongeur Ø 3.5mm	038-5100	19.0cm, 7 1/2"
	LANDOLT Tumor Grasping Forceps, blunt Ø 9.0mm	038-5102	20.0cm, 8"

OLDBERG