

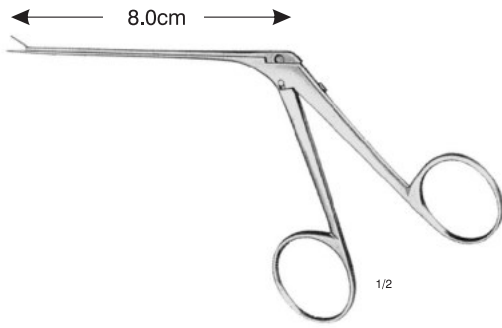

# ENT Surgery

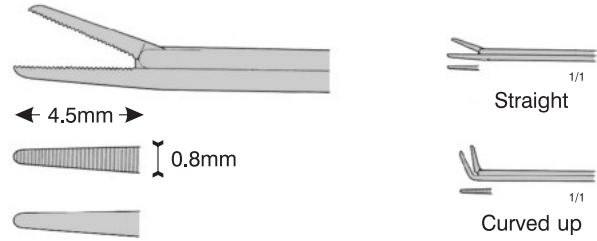

ALLIGATOR



041-0101	4.5x0.8mm	Straight	Serrated
041-0102	4.5x0.8mm	Straight	Smooth
041-0103	8.5x0.8mm	Straight	Serrated
041-0111	4.5x0.8mm	Curved	Serrated

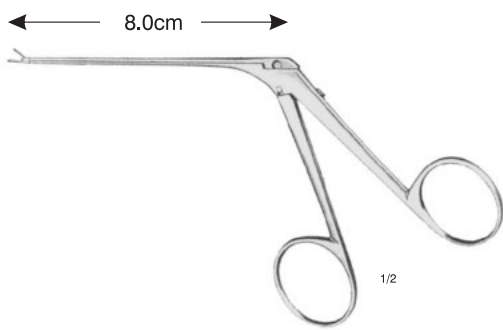

ALLIGATOR

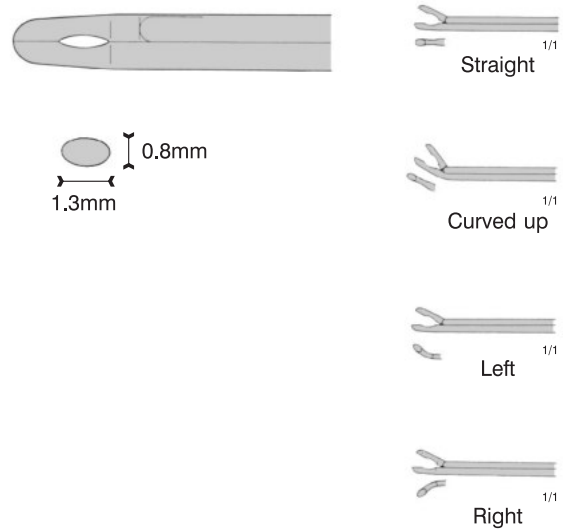

041-0201	1.3x0.8mm	Straight	
041-0211	1.3x0.8mm	Curved up	
041-0212	1.3x0.8mm	Left	
041-0213	1.3x0.8mm	Right	

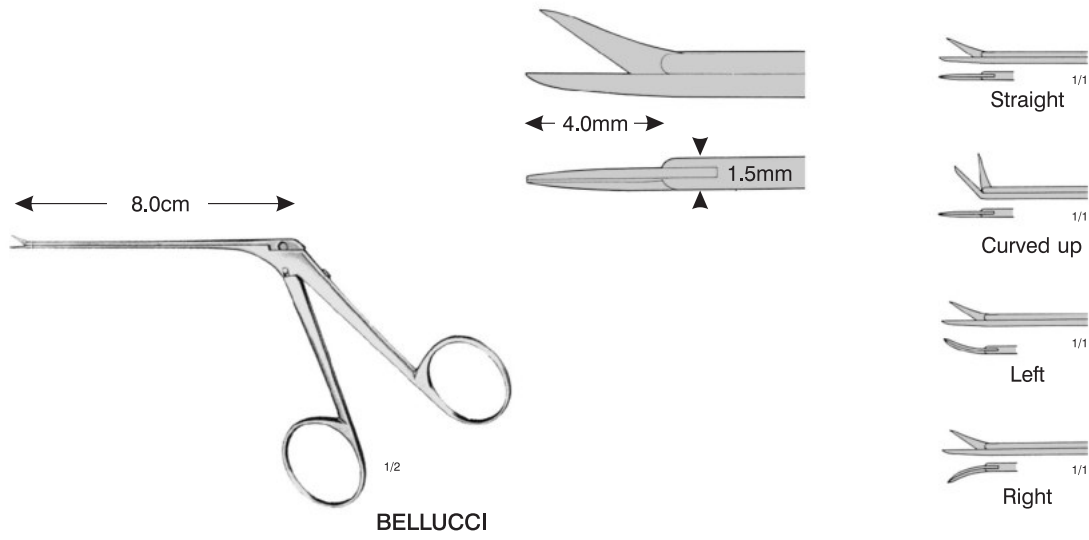

BELLUCCI

041-0301	1.5x4.0mm	Straight
041-0311	1.5x4.0mm	Curved up
041-0312	1.5x4.0mm	Left
041-0313	1.5x4.0mm	Right

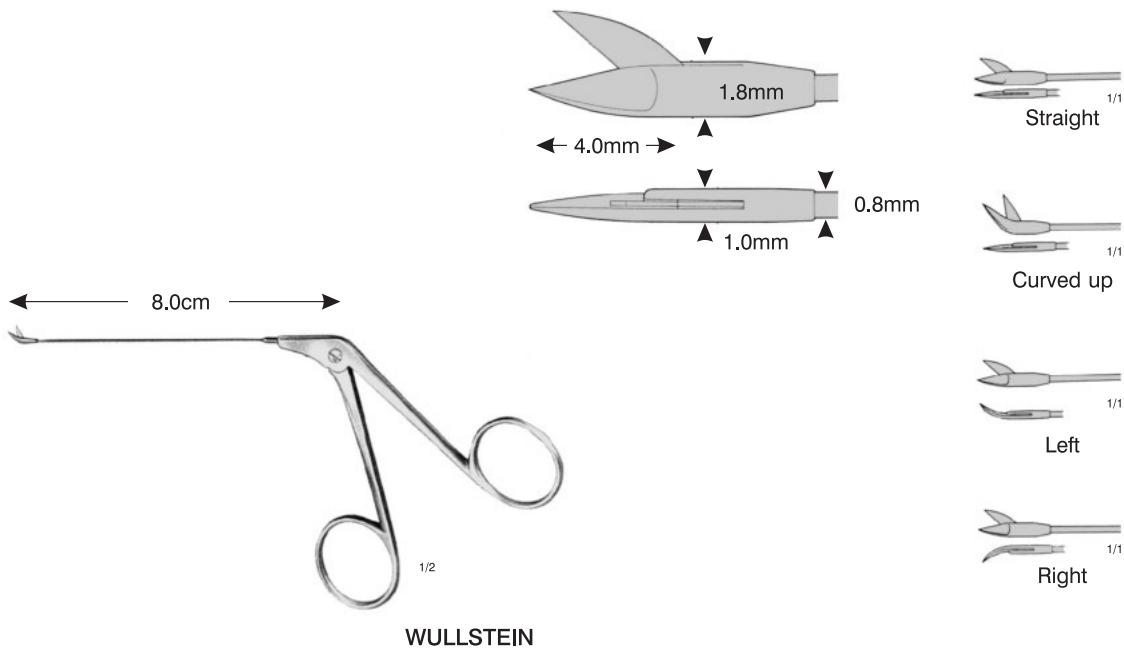

WULLSTEIN

041-0401	4.0x0.8mm	Straight
041-0411	4.0x0.8mm	Curved up
041-0412	4.0x0.8mm	Left
041-0413	4.0x0.8mm	Right

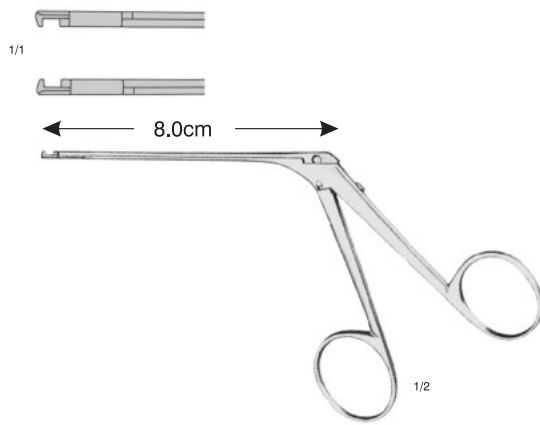
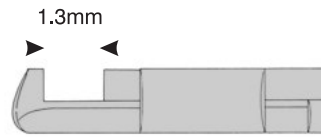

HOUSE-DIETER

041-0501	1.3mm	Down
041-0502	1.3mm	Up

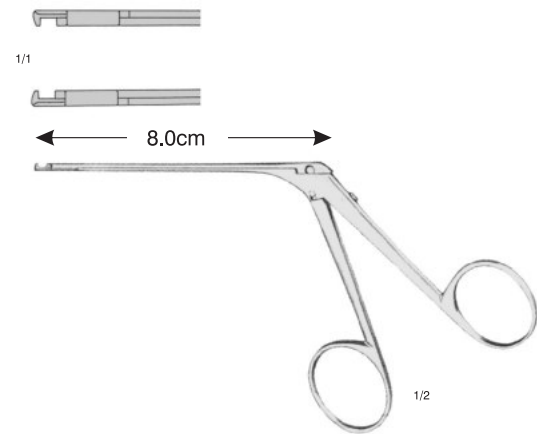

HOUSE-DIETER

041-0503	1.3mm	Left
041-0504	1.3mm	Right



HARTMANN-WULLSTEIN

041-0701 | 8.5cm, 3 1/3"

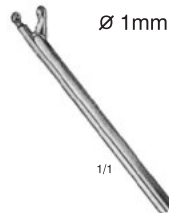

HARTMANN-WULLSTEIN

041-0702 | 8.5cm, 3 1/3"

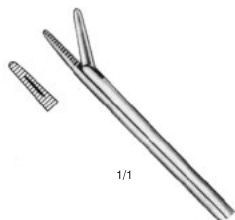
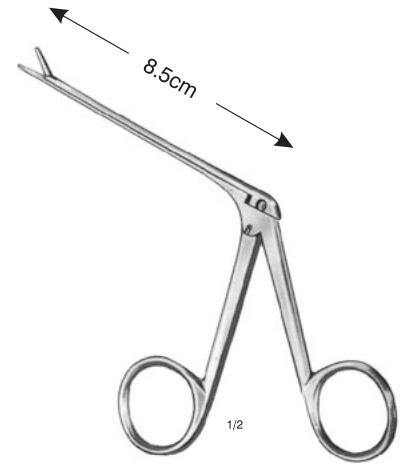

HARTMANN

041-0801 | 8.5cm, 3 1/3"  
041-0802 | 14.0cm, 5 1/2"  
041-0803 | 16.0cm, 6 1/4"



HARTMANN

041-0810 | 8.5cm, 3 1/3" | 1x2 teeth  
041-0820 | 14.0cm, 5 1/2" | 1x2 teeth



HARTMANN-NOYES

041-0900 | 9cm, 3 1/2"

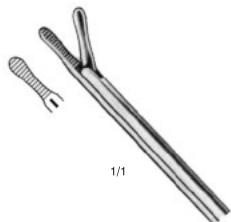

DUCKBILL

041-1000 | 8.5cm, 3 1/3"



WEINGARTNER

041-1100 | 8.5cm, 3 1/3"

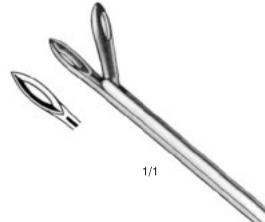

STRUMPEL

041-1200 | 8.5cm, 3 1/3"

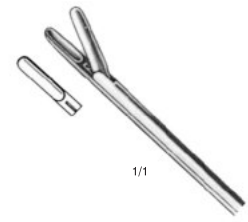

HARTMANN

041-1300 | 8.5cm, 3 1/3"

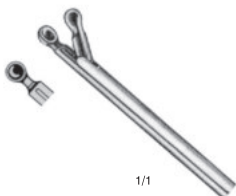

HARTMANN  
Straight

041-1401 | 8.5cm, 3 1/3" | 2.0mm  
041-1402 | 8.5cm, 3 1/3" | 2.5mm  
041-1403 | 8.5cm, 3 1/3" | 3.0mm

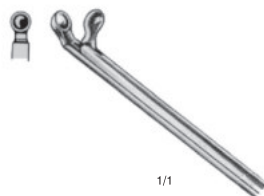

HARTMANN  
Curved up

041-1411 | 8.5cm, 3 1/3" | 2.0mm  
041-1412 | 8.5cm, 3 1/3" | 2.5mm  
041-1413 | 8.5cm, 3 1/3" | 3.0mm

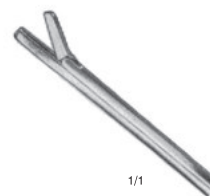

HARTMANN

041-1500 | 8.5cm, 3 1/3"



HARTMANN-HOFFMANN

041-1600 | 8.5cm, 3 1/3"



TROELTSCH

- 001-2201 | 11.0cm, 4 1/2"
- 001-2202 | 13.0cm, 5"



TROELTSCH (WILDE)  
Cross Action

- 001-2401 | 13.0cm, 5"



JANSEN

- ▶ 001-1701 | 14.0cm, 5 1/2"
- ▶ 001-1702 | 16.0cm, 6 1/4"
- ▶ 001-1703 | 18.0cm, 7"

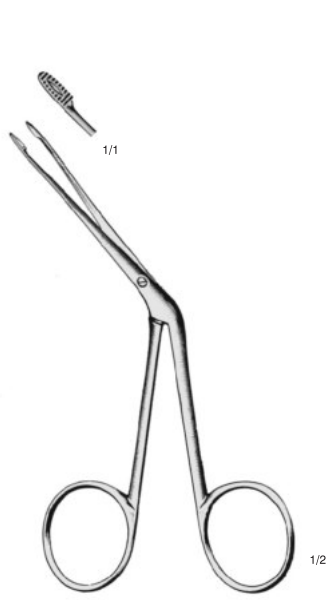

HARTMANN

041-1701 | 12.0cm, 4 3/4"



HARTMANN-HOFFMANN

041-1702 | 14.0cm, 5 1/2"

Laminectomy Punches

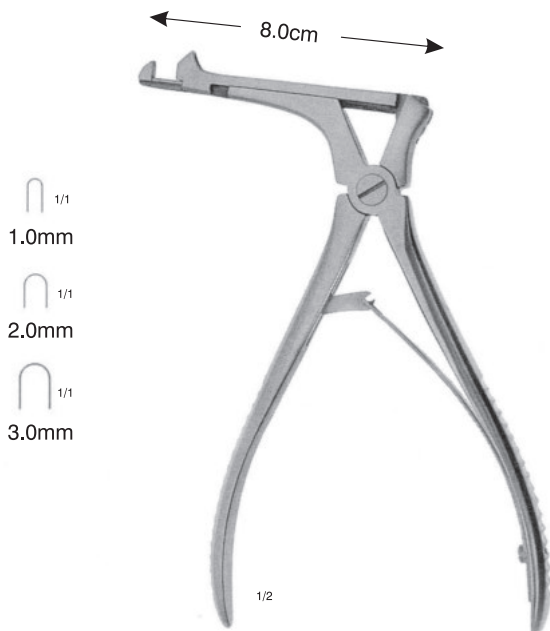

CITELLY

038-2501	1.0mm
038-2502	2.0mm
038-2503	3.0mm

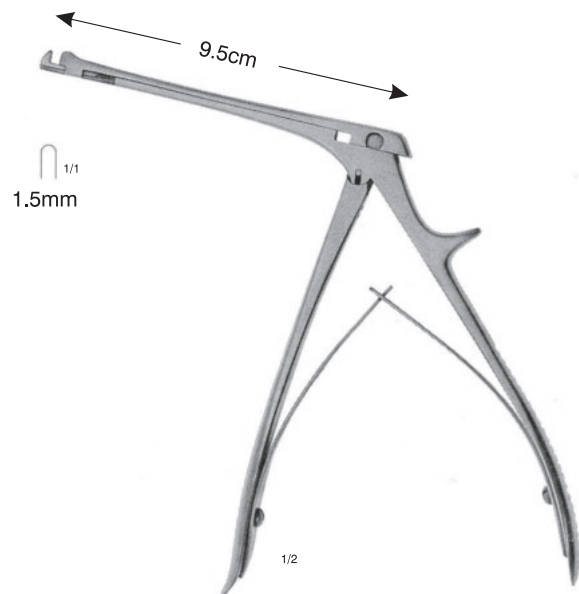

BEYER

038-2510



1/1  
BARBARA

041-1801



1/1  
Blunt

041-1802



1/1  
Sharp

041-1803



1/1  
ROSEN

041-1901



75°

1/1

041-2001	0.3mm
041-2002	0.6mm
041-2003	1.0mm



Hook

1/1

041-2301	0.5mm
041-2302	1.0mm



1/2

BARBARA  
16.0cm, 6 1/4"



45°

1/1

041-2101	0.3mm
041-2102	0.6mm
041-2103	1.0mm
041-2104	1.2mm
041-2105	1.5mm
041-2106	2.0mm
041-2107	2.5mm



90°

1/1

041-2201	0.3mm
041-2202	0.6mm
041-2203	1.0mm
041-2204	1.2mm
041-2205	1.5mm
041-2206	2.0mm
041-2207	2.5mm





**BARBARA**  
16.0cm, 6 1/4"



041-2211	0.3mm
041-2212	0.6mm
041-2213	1.0mm



041-2221	0.3mm
041-2222	0.6mm
041-2223	1.0mm



**MCGEE**

041-2311	0.5mm
041-2312	1.0mm



**MCGEE**

041-2321	0.5mm
041-2322	1.0mm



**BARBARA**  
16.0cm, 6 1/4"



**BARBARA**

041-1811



041-2011	0.3mm
041-2012	0.6mm
041-2013	1.0mm



041-2021	0.3mm
041-2022	0.6mm
041-2023	1.0mm



**ROSEN**

041-1911



041-2111	0.3mm
041-2112	0.6mm
041-2113	1.0mm



041-2121	0.3mm
041-2122	0.6mm
041-2123	1.0mm

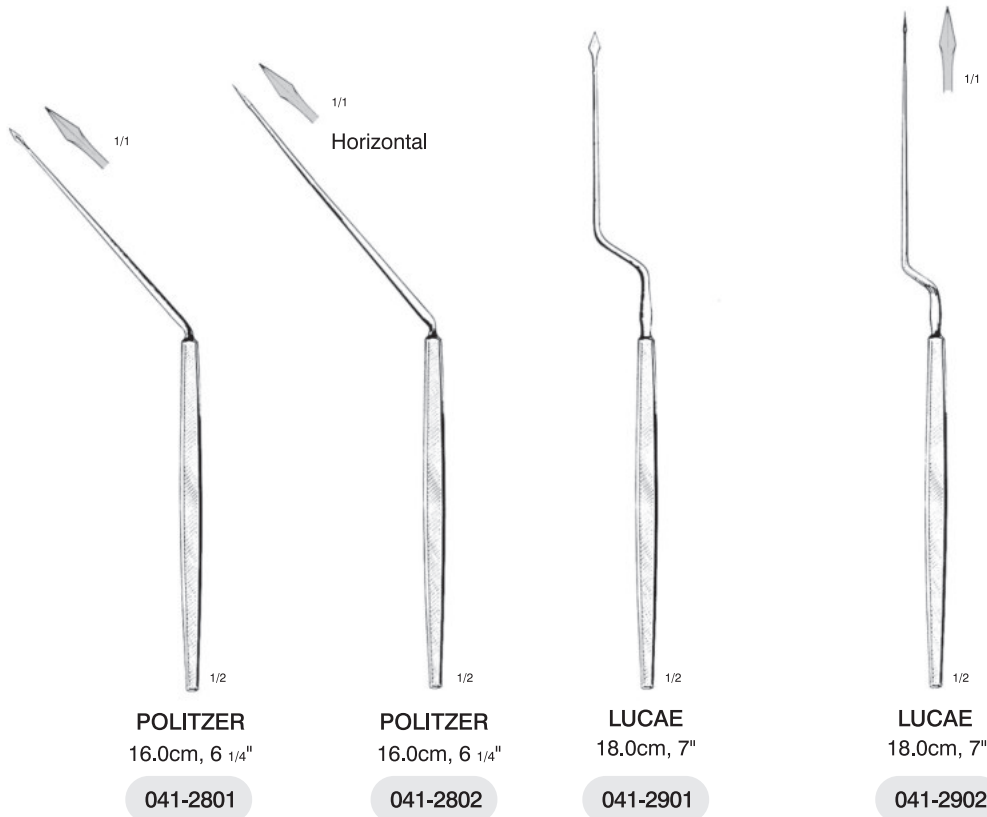
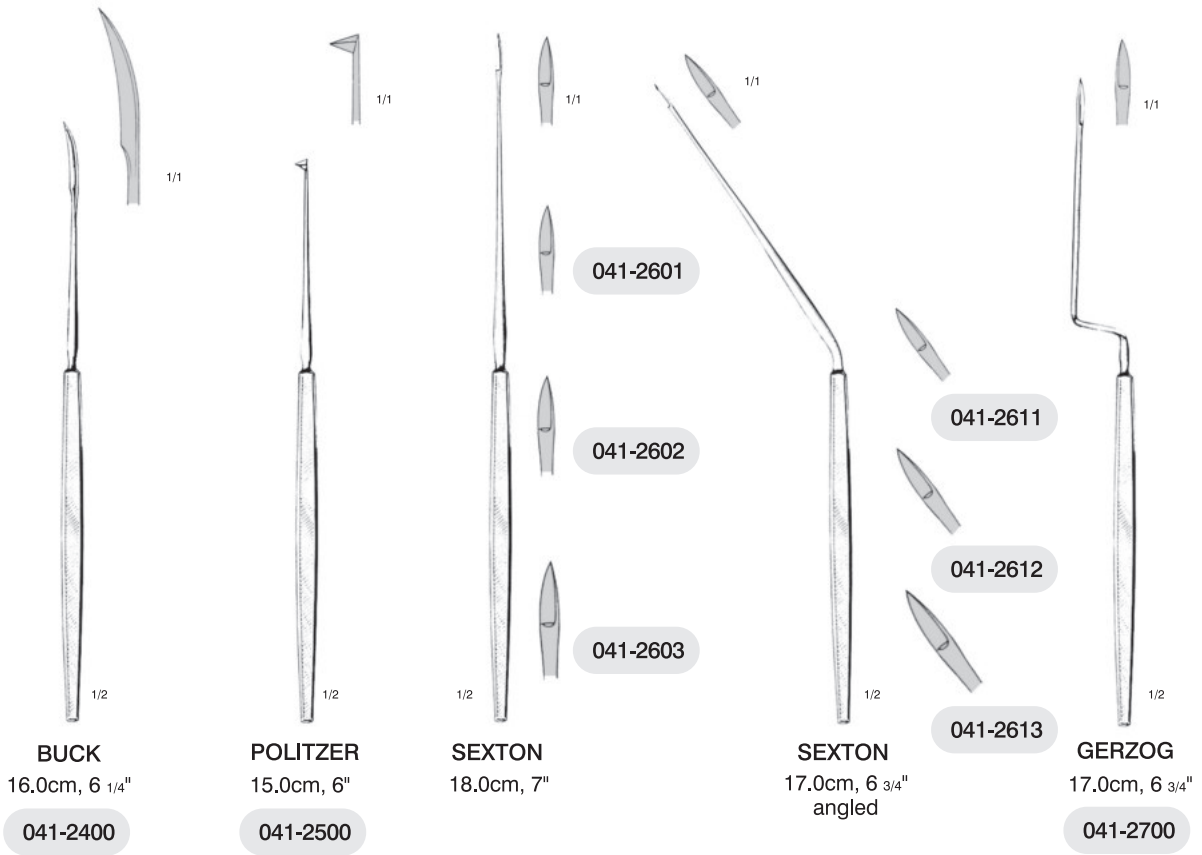



**SCHUKNECHT**  
16.0cm, 6 1/4"

041-3000

**WULLSTEIN**  
16.0cm, 6 1/4"

041-3100

**TABB**  
16.0cm, 6 1/4"

041-3200

**PLESTER**  
16.0cm, 6 1/4"

041-3300

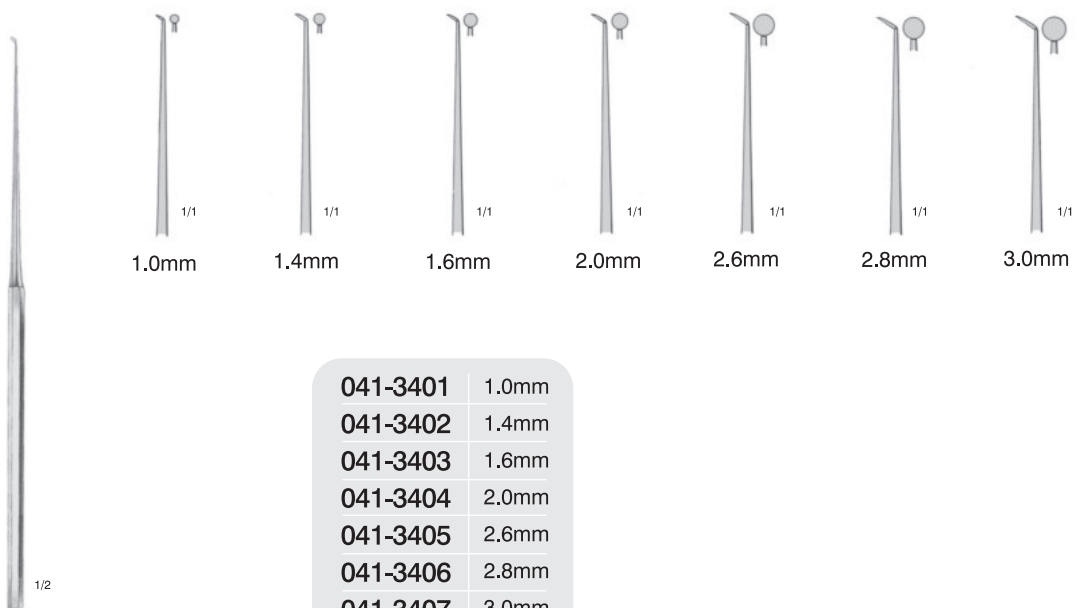

**ROSEN**  
16.0cm, 6 1/4"

041-3401	1.0mm
041-3402	1.4mm
041-3403	1.6mm
041-3404	2.0mm
041-3405	2.6mm
041-3406	2.8mm
041-3407	3.0mm

Double Angled



**FISCH**  
16.0cm, 6 1/4"

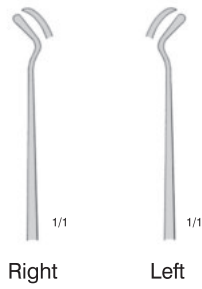

041-3501	Right
041-3502	Left



041-3503	Right
041-3504	Left



Fig.1



Fig.2



Fig.3



Scoop  
Fig.4



Fig.5



Elevator  
Fig.6



**ROSEN**  
16.0cm, 6 1/4"

041-3601	Fig.1
041-3602	Fig.2
041-3603	Fig.3
041-3604	Fig.4
041-3605	Fig.5
041-3606	Fig.6



3.5mm



4.0mm



4.5mm



5.0mm



**HOUSE**  
16.0cm, 6 1/4"

041-3701	3.5mm
041-3702	4.0mm
041-3703	4.5mm
041-3704	5.0mm

041-3801	2.0mm
041-3802	3.0mm
041-3803	4.0mm

041-3901	#1
041-3902	#2
041-3903	#3
041-3904	#4
041-3905	#5

**LUCAE**  
14.0cm, 5 1/2"

**WAGENER**  
14.0cm, 5 1/2"

041-4001	041-4002	041-4003	041-4004	041-4005	041-4006	041-4007
041-4011	041-4012	041-4013	041-4014	041-4015	041-4016	041-4017
041-4101	041-4102	041-4103	041-4104	041-4105	041-4106	041-4107
041-4111	041-4112	041-4113	041-4114	041-4115	041-4116	041-4117

**BUCK**  
16.0cm, 6 1/4"

Sharp

Blunt



JANSEN

041-4200 | 15.0cm, 6"



BARTH

041-4300 | 18.0cm, 7"



TOYNBEE



#1



#2



#3



#4



#5

041-4400	SET
041-4401	4.0mm #1
041-4402	5.5mm #2
041-4403	7.0mm #3
041-4404	8.5mm #4
041-4405	10.0mm #5

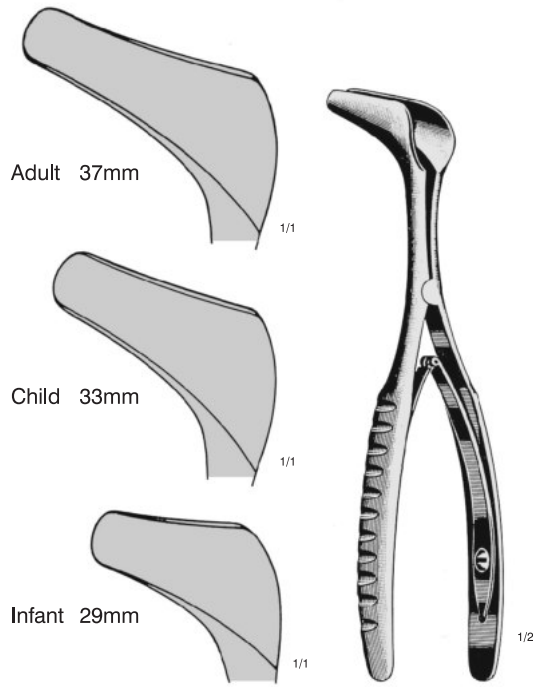

**HARTMANN**

- ▶ 042-0201 29mm Infant
- ▶ 042-0202 33mm Child
- ▶ 042-0203 37mm Adult

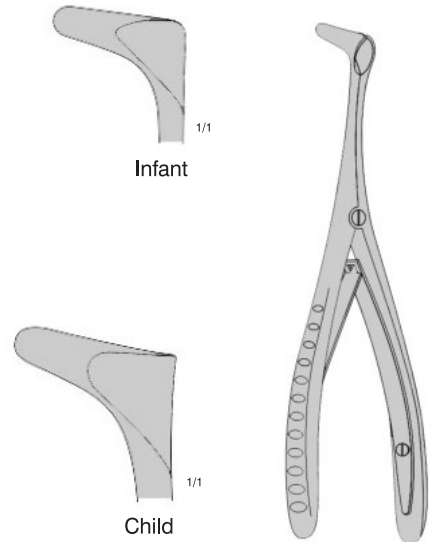

**HALLE-TIECK**  
13.0cm, 5"

- 042-0210 Infant
- 042-0220 Child

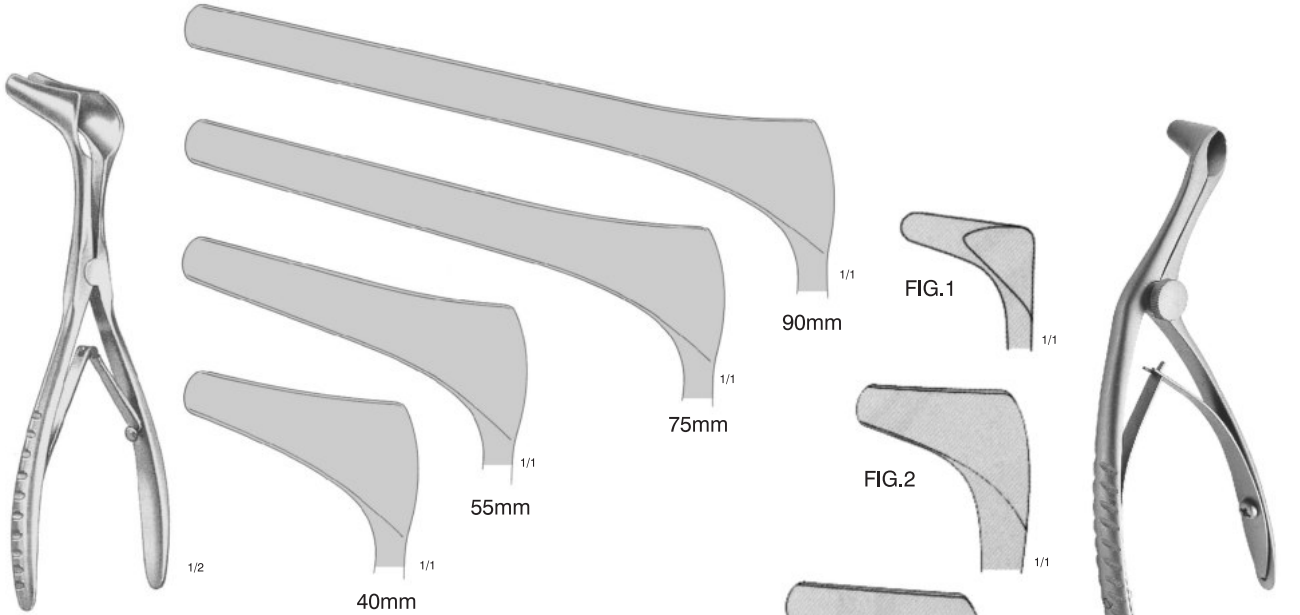

**KILLIAN**

- 042-0301 40mm
- ▶ 042-0302 55mm
- ▶ 042-0303 75mm
- ▶ 042-0304 90mm

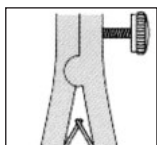

**SCREW STOP**

- 042-0310 40mm
- 042-0320 55mm
- 042-0330 75mm
- 042-0340 90mm

**BECKMAN**

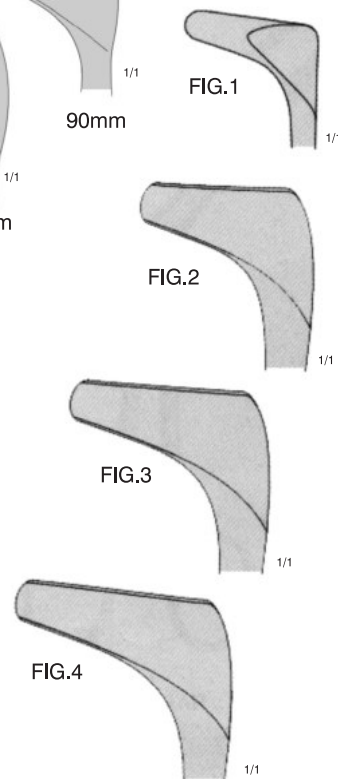

- 042-0400 FIG.1
- ▶ 042-0401 FIG.2
- 042-0402 FIG.3
- 042-0403 FIG.4

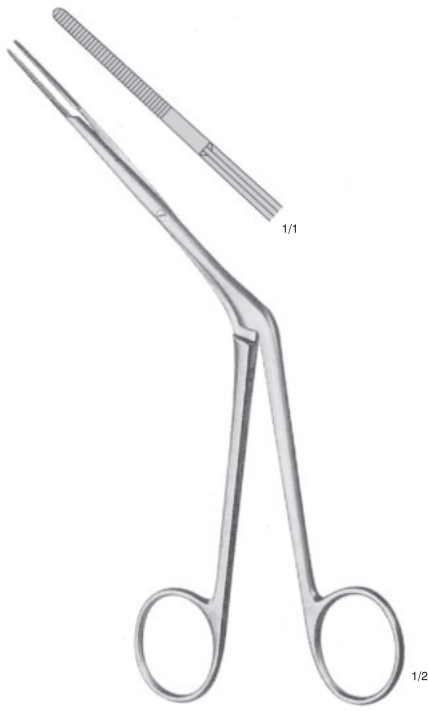

WESTMACOTT

042-0500 | 20.0cm, 8"

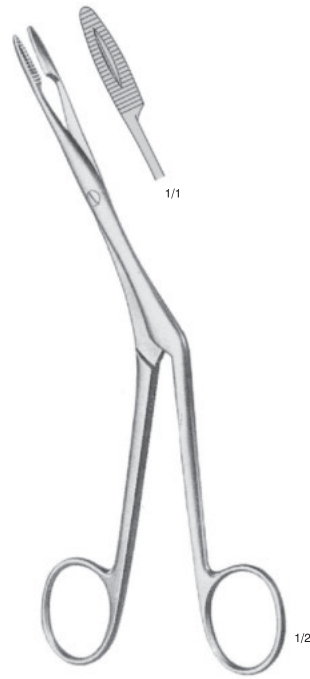

HEYMANN-KNIGHT

042-0601 | 18.0cm, 7"

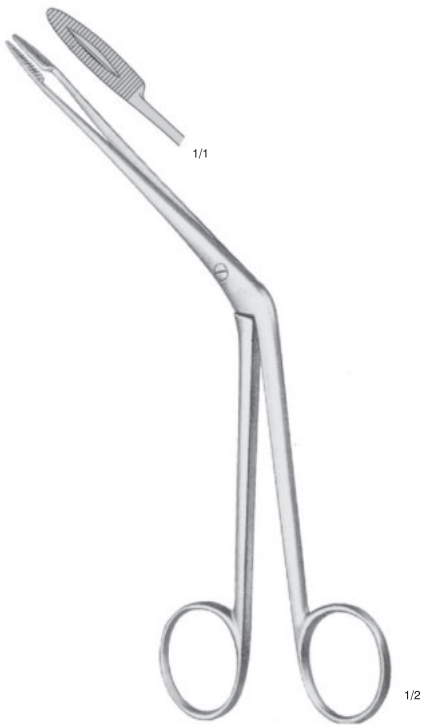

HARTMANN

042-0602 | 20.0cm, 8"



KILLIAN

042-0610 | 17.0cm, 6 3/4"



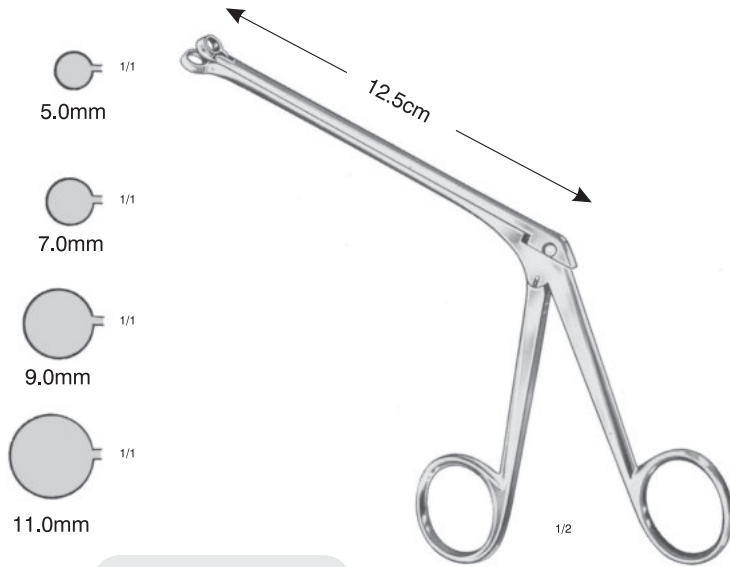

042-0701	5.0mm
042-0702	7.0mm
042-0703	9.0mm
042-0704	11.0mm

**HARTMANN**  
12.5cm, 5"

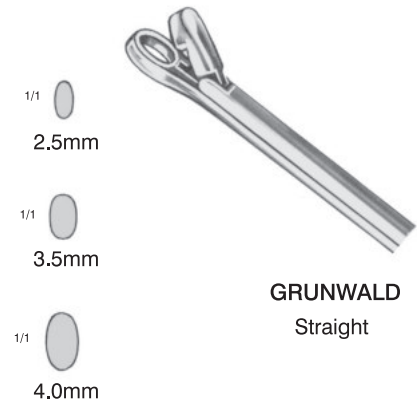

**GRUNWALD**  
Straight

042-0801	2.5mm
042-0802	3.5mm
042-0803	4.0mm

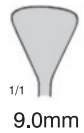
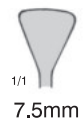

**SCHMEDEN**

042-0901	6.0mm
042-0902	7.5mm
042-0903	9.0mm



042-1000	4.0mm
----------	-------



**GRUNWALD**  
Curved Up



**MYLES**

042-1101	2.2mm
042-1102	2.6mm
042-1103	3.0mm
042-1104	3.4mm

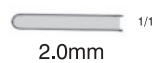

**STRUYCKEN**

042-1201	1.0mm
042-1202	2.0mm

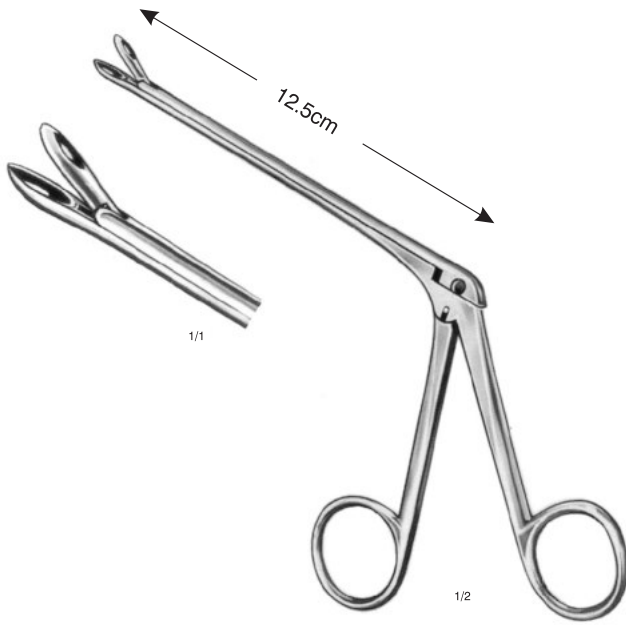

**WEIL-BLAKESLEY**  
Straight



**038-4001** | 3.0mm



**038-4002** | 3.6mm



**038-4003** | 4.2mm



**038-4004** | 4.8mm



**038-4005** | 5.8mm



**WATSON-WILLIAMS**

**042-1300** | 12.5cm, 5"

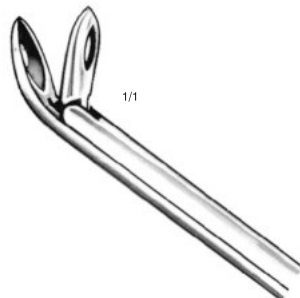

**WEIL-BLAKESLEY**  
Curved Up



**038-4012** | 3.6mm



**038-4013** | 4.2mm



**038-4014** | 4.8mm



**WATSON-WILLIAMS**  
Straight

**042-1401** | 12.5cm, 5"

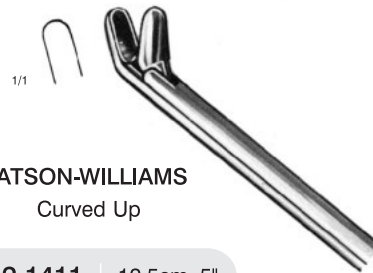

**WATSON-WILLIAMS**  
Curved Up

**042-1411** | 12.5cm, 5"



042-1501	1.0mm
042-1502	2.0mm

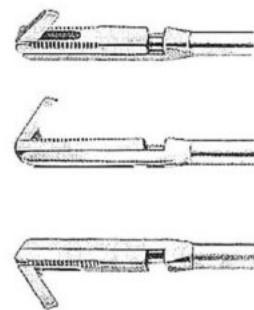
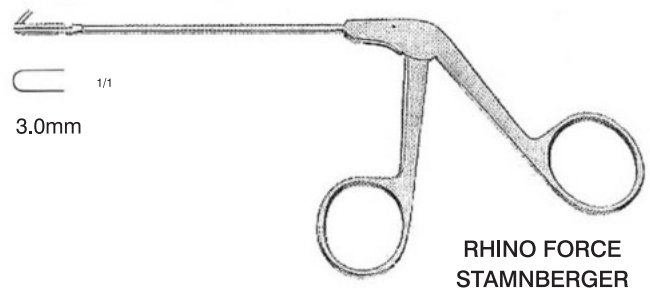
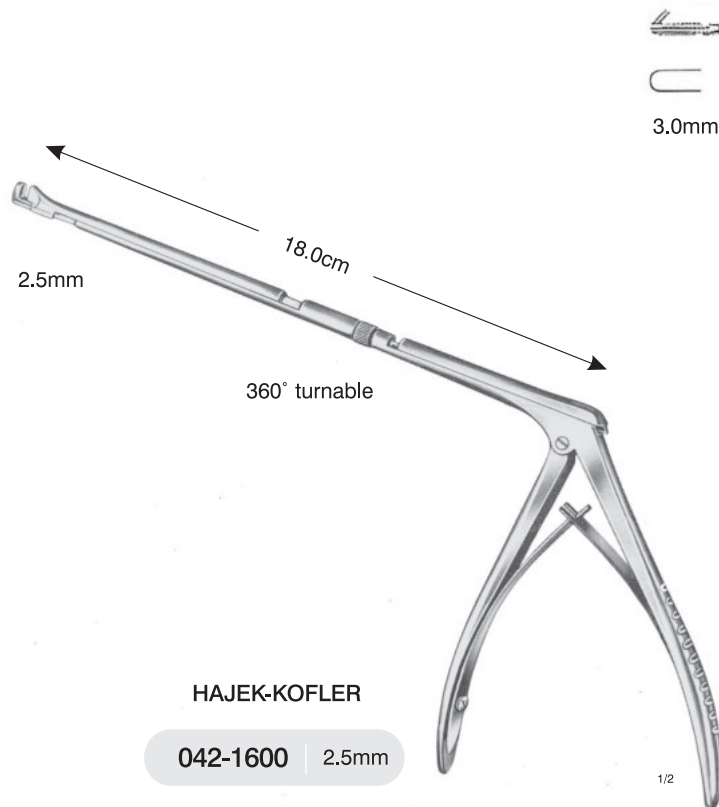

042-1701	Up Bite
042-1702	Right Bite
042-1703	Left Bite



038-2601	3.0mm
038-2602	4.0mm
038-2603	5.0mm
038-2604	6.0mm



**KERRISON**  
Upwards cutting 90°

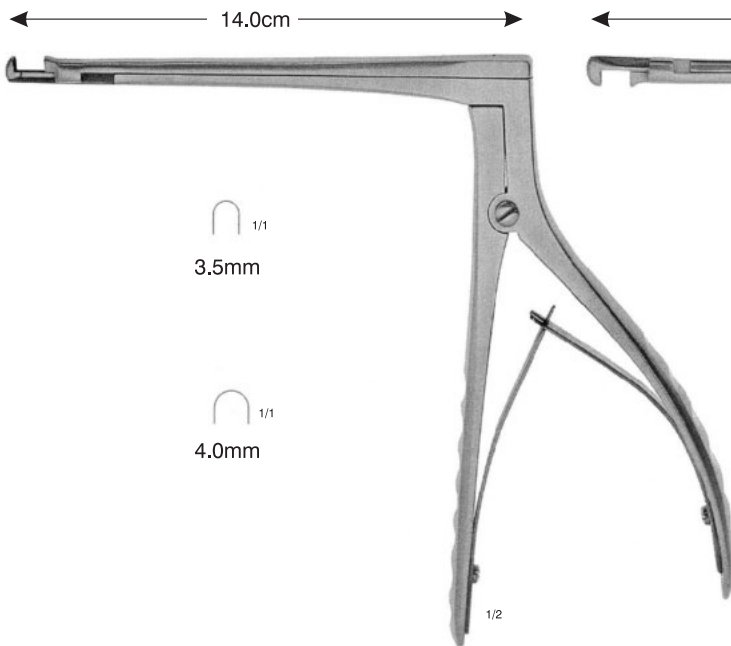

**HAJEK-KOFLER**  
Upwards cutting 90°

038-2701	3.5mm
038-2702	4.0mm

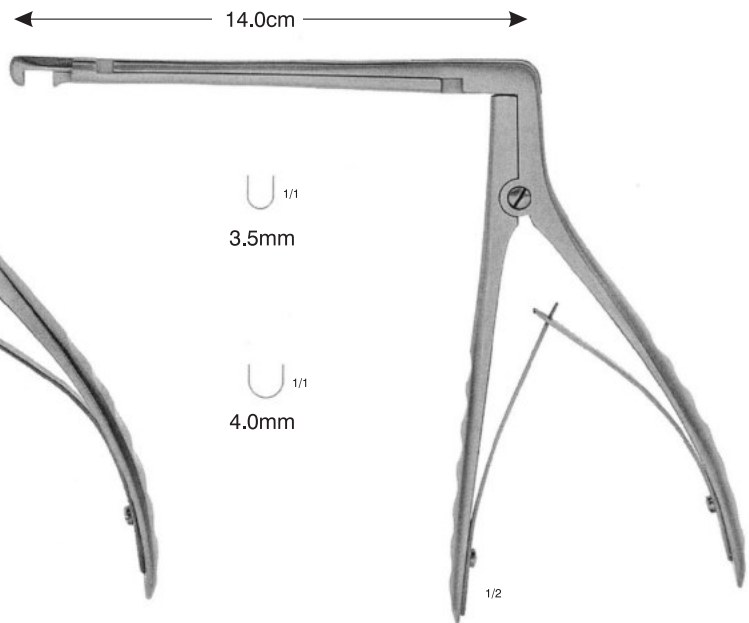

**HAJEK-KOFLER**  
Downwards cutting 90°

038-2711	3.5mm
038-2712	4.0mm



**MIDDLETON-JANSEN**  
Punch

042-1810 | 19.0cm, 7 1/2"



**MIDDLETON-JANSEN**  
Rongeur

042-1820 | 19.0cm, 7 1/2"



**BECKER-SCHERE**  
Scissor

042-1900 | 20.0cm, 8"



**RUBIN**  
Forceps

042-2000 | 20.0cm, 8"



1/2

JOSEPH

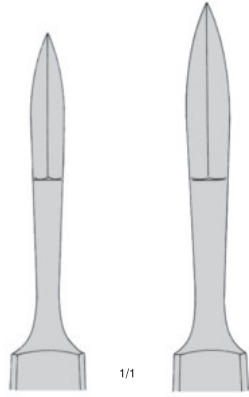

1/1

042-2101 14.5cm, 5 3/4" Straight

042-2102 16.0cm, 6 1/4" Straight

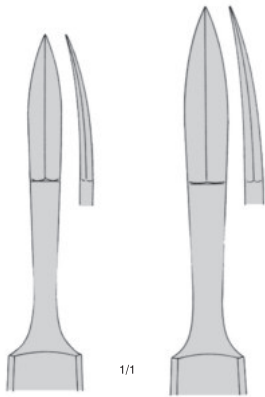

1/1

042-2111 14.5cm, 5 3/4" Curved

042-2112 16.0cm, 6 1/4" Curved

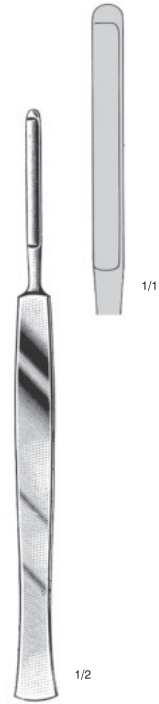

1/2

JOSEPH

042-2201 15.0cm, 6"

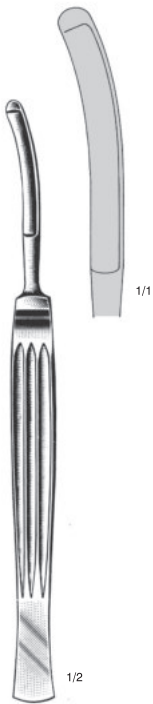

1/2

CONVERS

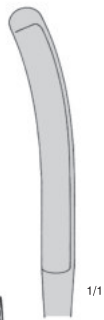

1/1

042-2211 16.0cm, 6 1/4"



1/2

COTTLE

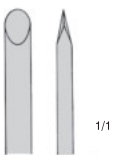

1/1

042-2202 15.0cm, 6"



1/2

COTTLE



1/1

042-2203 15.0cm, 6"



FREER



1/1

042-2204 15.0cm, 6"

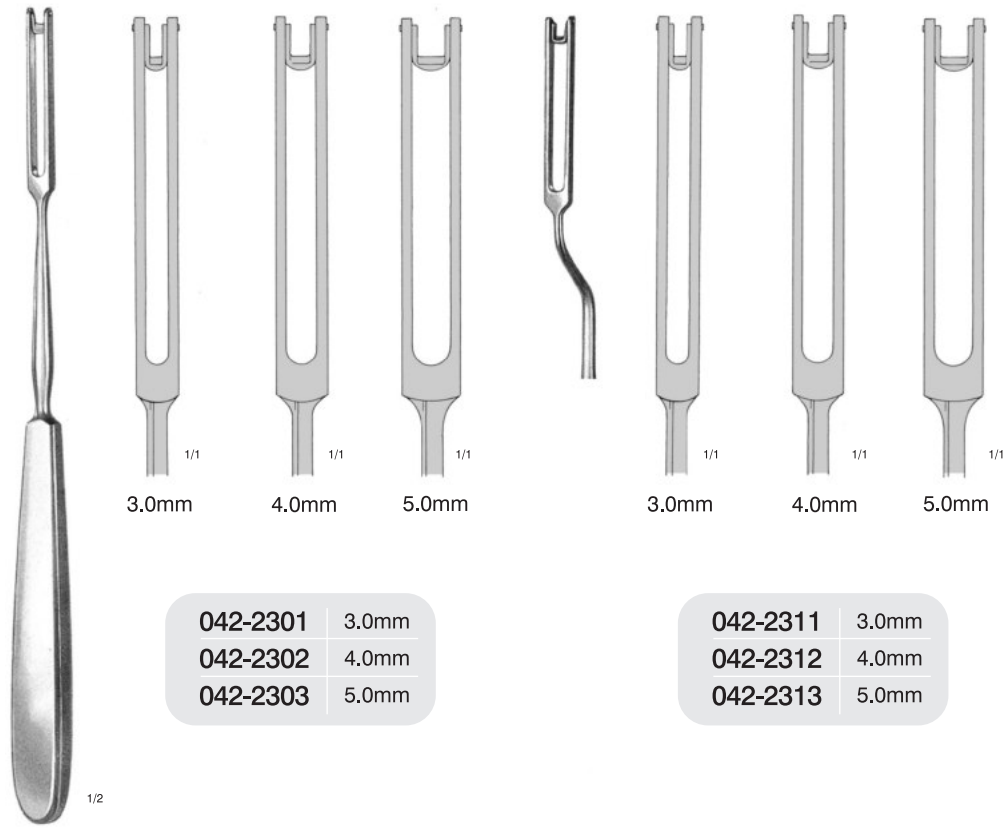

042-2301	3.0mm
042-2302	4.0mm
042-2303	5.0mm

042-2311	3.0mm
042-2312	4.0mm
042-2313	5.0mm

**BALLENGER**  
20.0cm, 8"



042-2400	9.0mm
----------	-------

042-2501	4.0mm
042-2502	5.0mm

**MC KENTY**  
15.5cm, 6 1/8"

**BOIES**  
17.0cm, 6 3/4"

► 042-2600

**COTTLE**  
19.0cm, 7 1/2"

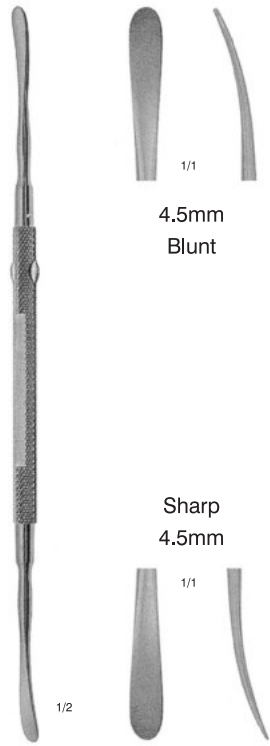

4.5mm  
Blunt

Sharp  
4.5mm

FREER

▶ 037-0801 | 19.0cm, 7 1/2"

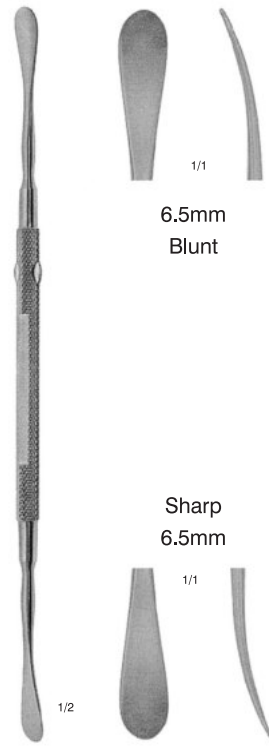

6.5mm  
Blunt

Sharp  
6.5mm

FREER

▶ 037-0802 | 19.0cm, 7 1/2"

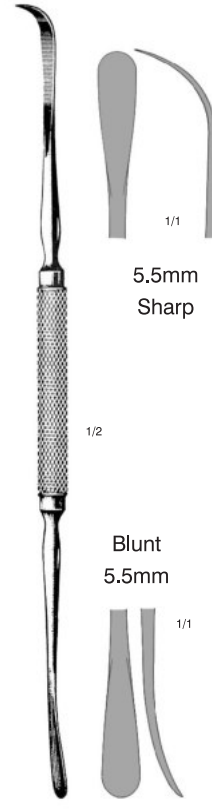

5.5mm  
Sharp

Blunt  
5.5mm

FREER

▶ 037-0803 | 21.0cm, 8 1/2"



4.5mm  
Sharp

FREER

▶ 037-0804 | 19.0cm, 7 1/2"



4.5mm  
Blunt

FREER

▶ 037-0805 | 19.0cm, 7 1/2"

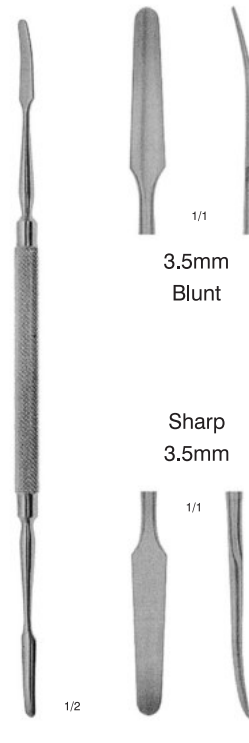

3.5mm  
Blunt

Sharp  
3.5mm

KILLIAN

▶ 037-0806 | 18.0cm, 7 1/2"



4.5mm



3.5mm

**FREER**  
21.0cm, 8 1/4"

► **042-2700** | 21.0cm, 8 1/4"



2.0mm



3.0mm



4.0mm



5.0mm



3.5mm



1/2

**JOSEPH**  
16.0cm, 6 1/4"

<b>042-2801</b>	2.0mm
<b>042-2802</b>	3.0mm
<b>042-2803</b>	4.0mm
<b>042-2804</b>	5.0mm
<b>042-2805</b>	3.5mm



1/1



1/2

**PENNINGTON**

**042-2900** | 21.0cm, 8 1/4"

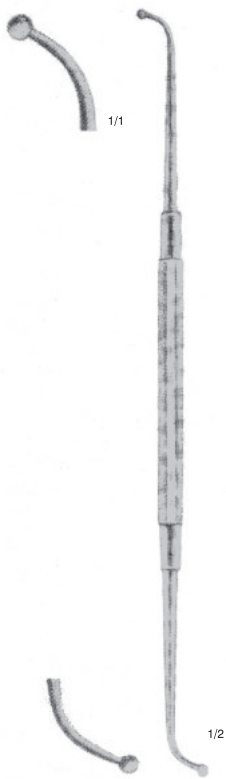

Double Ball Hook

042-3000 | 18.0cm, 7"

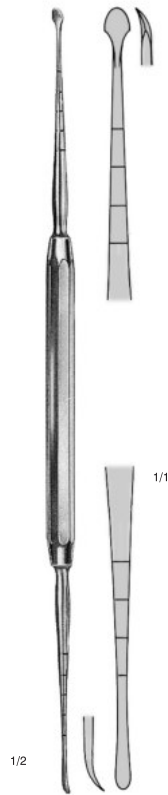

MASSING

042-3010 | 21.0cm, 8 1/4"

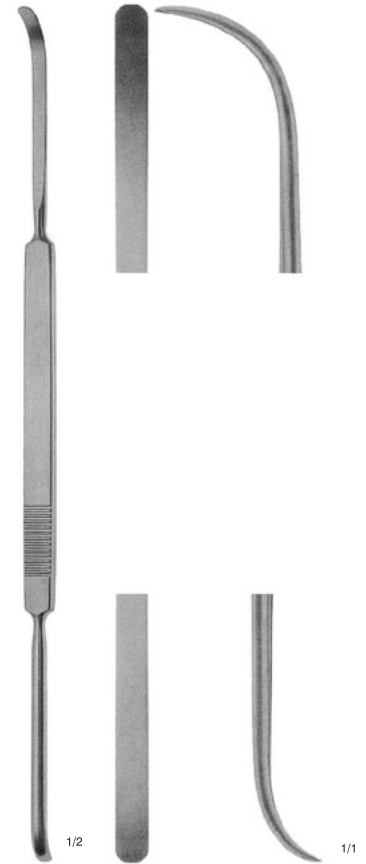

COTTLE

042-3020 | 23.0cm, 9"

2.0mm



**HEXAGONAL**  
16.0cm, 6 1/4"

► **042-3100** 2.0mm

4.0mm



**FREER**  
Chisel  
16.0cm, 6 1/4"

► **042-3201** Straight  
**042-3211** Curved

4.0mm



**FREER**  
Chisel  
16.0cm, 6 1/4"

6.0mm



**FREER**  
Gouge  
15.0cm, 6"

► **042-3202** 6.0mm

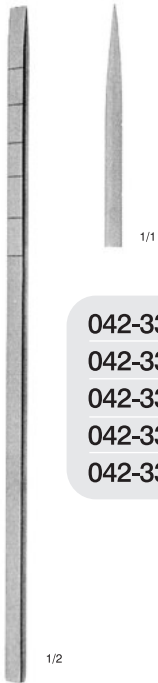

**042-3301** 4.0mm  
**042-3302** 6.0mm  
**042-3303** 8.0mm  
**042-3304** 10.0mm  
**042-3305** 12.0mm

**COTTLE**  
with depth marking  
18.0cm, 7"

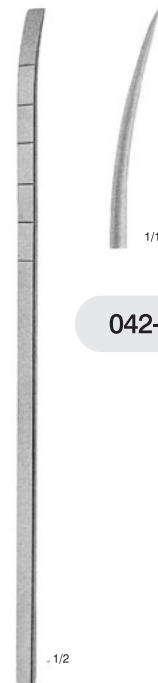

**042-3312** 6.0mm

**COTTLE**  
with depth marking  
18.0cm, 7"

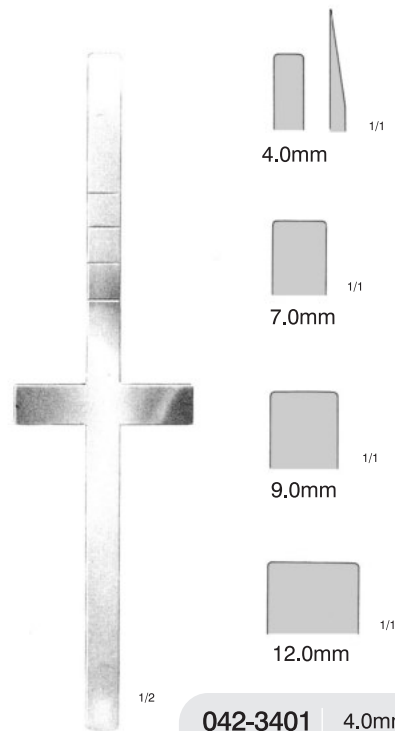

**042-3401** 4.0mm  
**042-3402** 7.0mm  
**042-3403** 9.0mm  
**042-3404** 12.0mm

**COTTLE**  
18.0cm, 7"



Straight

Right

Left

- ▶ 036-7801 Straight
- ▶ 036-7802 Right
- ▶ 036-7803 Left

**ANDERSON-NEIVERT**

21.5cm, 8 1/2"

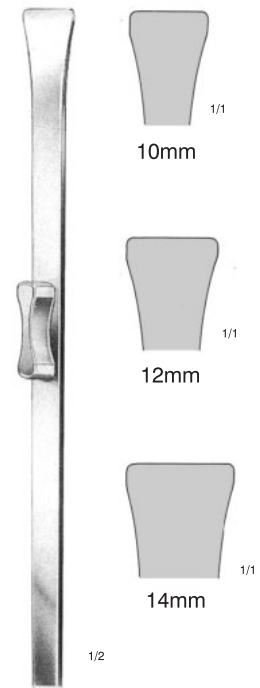

10mm

12mm

14mm

**RUBIN**

18.0cm, 7"

- ▶ 042-3501 10mm
- ▶ 042-3502 12mm
- ▶ 042-3503 14mm

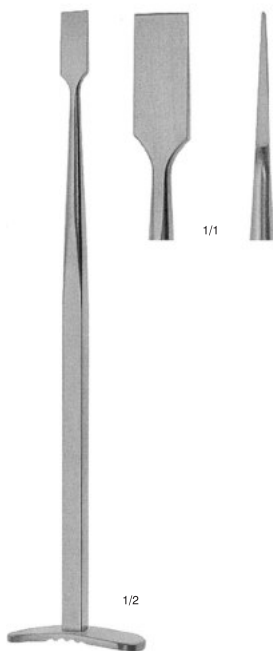

**SMILLIE**

- ▶ 036-7901 17.0cm, 6 3/4"

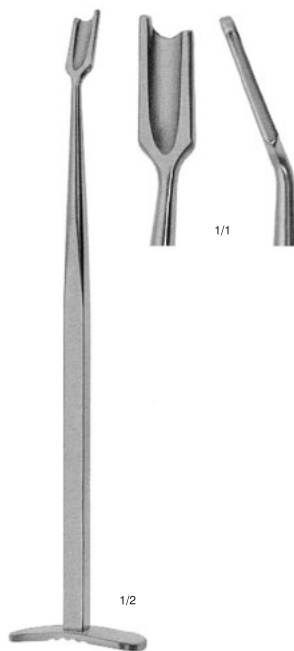

**SMILLIE**

- ▶ 036-7902 17.0cm, 6 3/4"

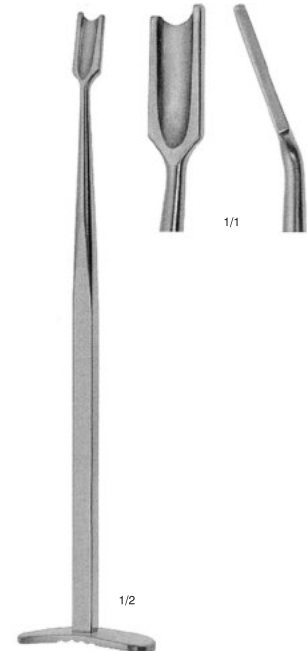

**SMILLIE**

- ▶ 036-7903 17.0cm, 6 3/4"



▶ 042-3601

**COTTLE**  
21.0cm, 8 1/4"

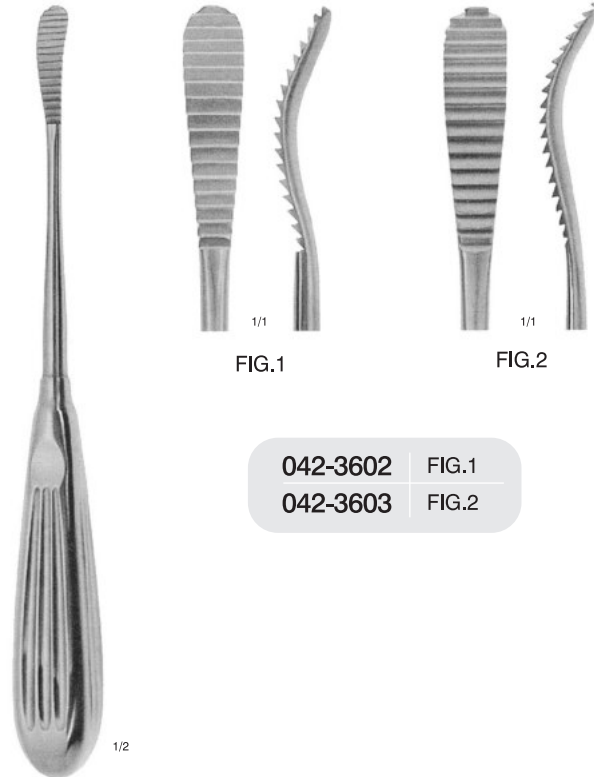

FIG.1

FIG.2

042-3602 | FIG.1

042-3603 | FIG.2

**AUFRICHT**  
21.0cm, 8 1/4"

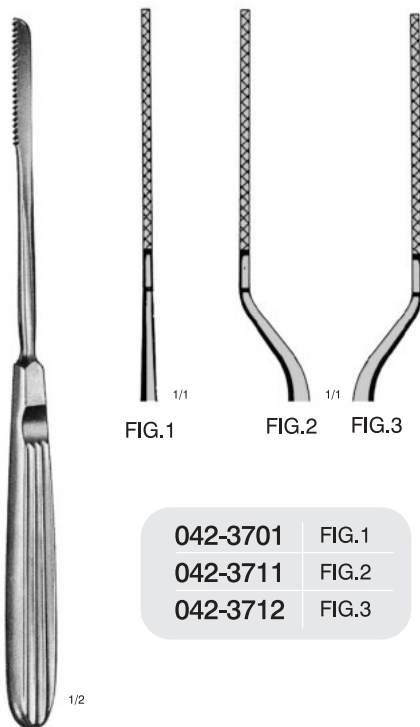

FIG.1

FIG.2

FIG.3

042-3701 | FIG.1

042-3711 | FIG.2

042-3712 | FIG.3

**JOSEPH**  
19.0cm, 7 1/2"



042-3800 | 21.0cm, 8 1/4"

**FOMON**



FOMON  
20.5cm, 8"



042-3901



042-3902



042-3903



042-3904



042-3905



1/1



1/1



1/1

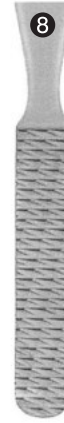

1/1



1/1



MILLER



1/1



1/1

041-4000 | 19.0cm, 7 1/2"

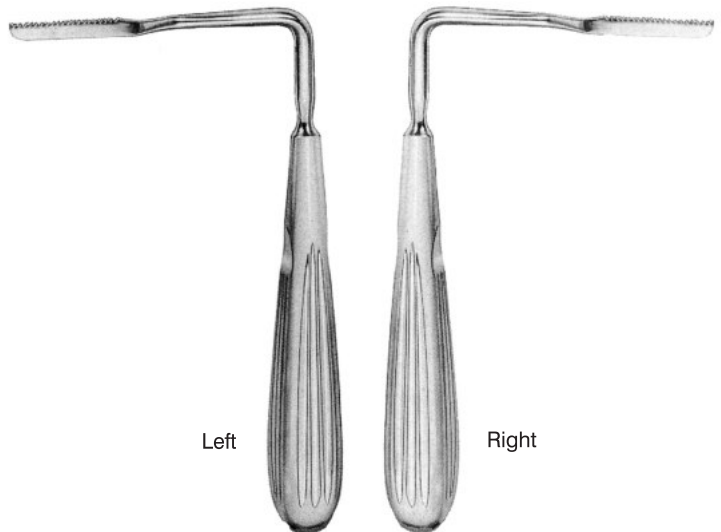

Left

Right

JOSEPH  
17.0cm, 6 3/4"

042-4101 | Left  
042-4102 | Right

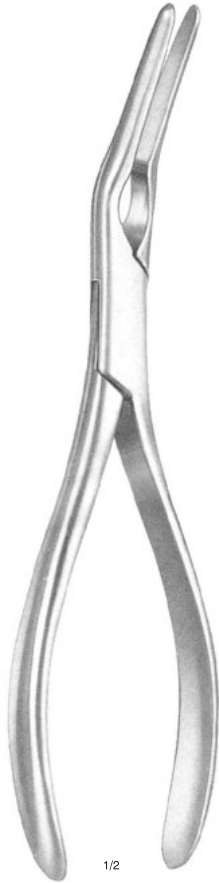

**ASH**  
Septum Forceps

▶ **042-4200** | 23.0cm, 9"



**WALSHAM**  
Septum Forceps  
23.0cm, 9"

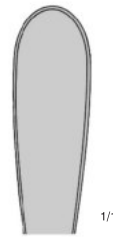

FIG.1



FIG.2



FIG.3

042-4301	FIG.1
042-4302	FIG.2
042-4303	FIG.3



5.6mm

**RAGNELL**  
Retractor

▶ **042-4400** | 15.3cm, 6 1/8"

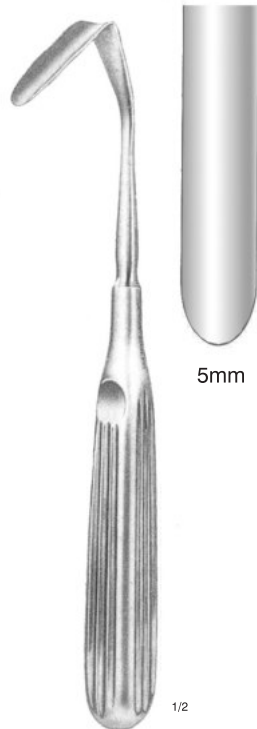

5mm

**AUFRICHT**  
Retractor

▶ **042-4500** | 18.0cm, 7"



**JUNG'S Forceps**

▶ **042-4600** | 18.0cm, 7"

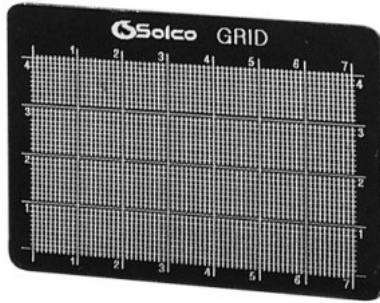

GRID

▶ 042-4700 | 57x83mm



CATIRAGE CRUSHER

▶ 042-4800

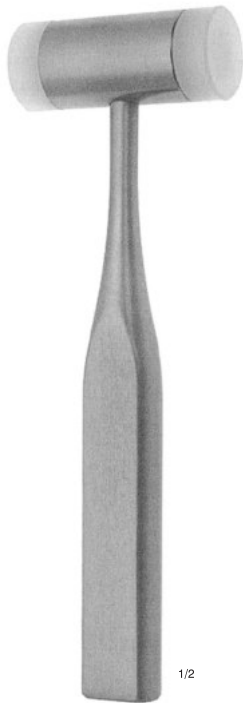

MALLET

with plastic disks  
18.0cm, 7"

▶ 036-8630 | Ø 30mm | 500g



GORNEY

Suction Dissector

▶ 042-4900 | 18.0cm, 7"





HURD

► 043-0101 22.5cm, 9 1/4"



KING-HURD

► 043-0102 17.0cm, 6 3/4"

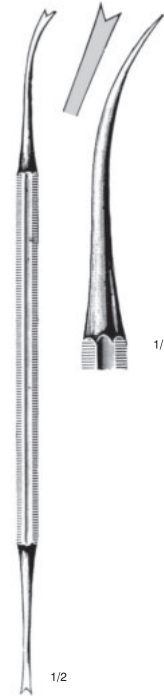

LUNIATSCHEK

043-0200 19.0cm, 7 1/2"



NAGER

043-0400 24.0cm, 9 1/2"



LOPEZ-REINKE  
Suction Dissector

043-0500 23.5cm, 9 1/4"



- ▶ 043-0601 Straight
- ▶ 043-0611 Curved

**COLVER**  
19.0cm, 7 1/2"



**BALLENGER**  
3x3 teeth

043-0700 | 20.3cm, 8"



**TIVNEN**  
3x3 teeth

▶ 043-0800 | 18.5cm, 7 1/4"

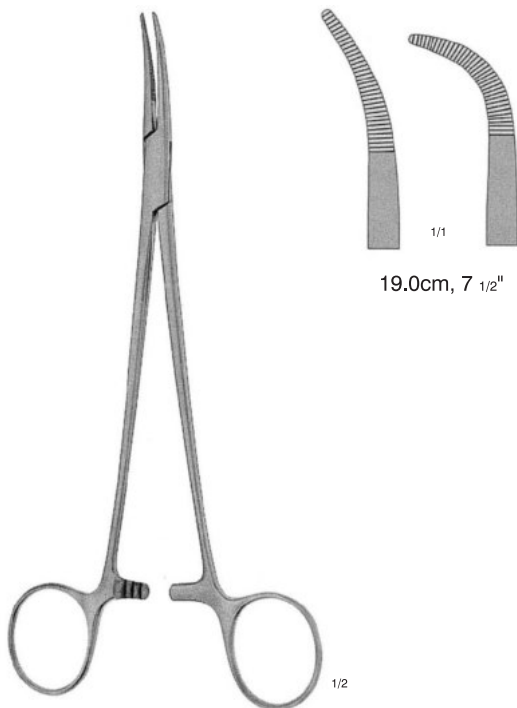

19.0cm, 7 1/2"

**SCHNIDT-SAWTELL**

- ▶ 013-1911 19.0cm, 7 1/2" Slightly Curved
- ▶ 013-1912 19.0cm, 7 1/2" Full Curved

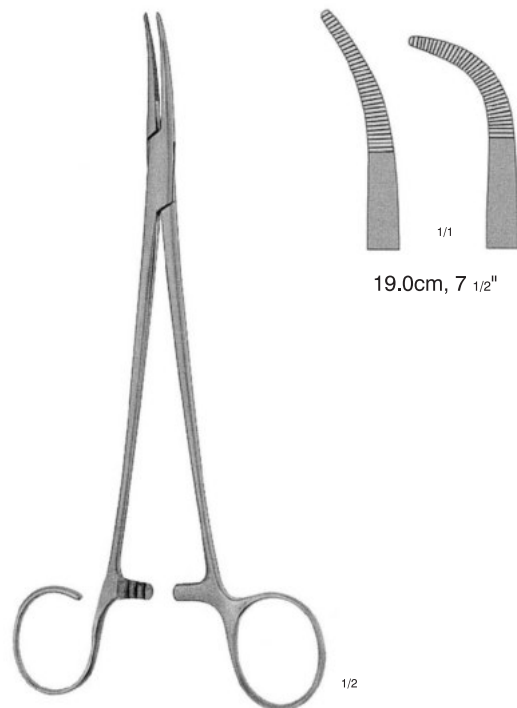

19.0cm, 7 1/2"

**SCHNIDT-SAWTELL**  
with open ring

- 013-1921 19.0cm, 7 1/2" Slightly Curved
- 013-1922 19.0cm, 7 1/2" Full Curved



LAHEY

043-0810	15.0cm, 6"	3x3 teeth
043-0820	20.0cm, 8"	3x3 teeth

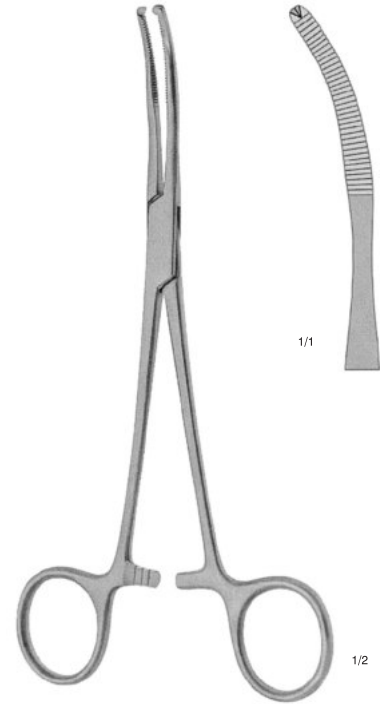

MIKULICZ

043-0830	18.0cm, 7"	1x2 teeth
----------	------------	-----------



SCHINDLER  
1x2 teeth

043-0840	19.0cm, 7 1/2"
----------	----------------

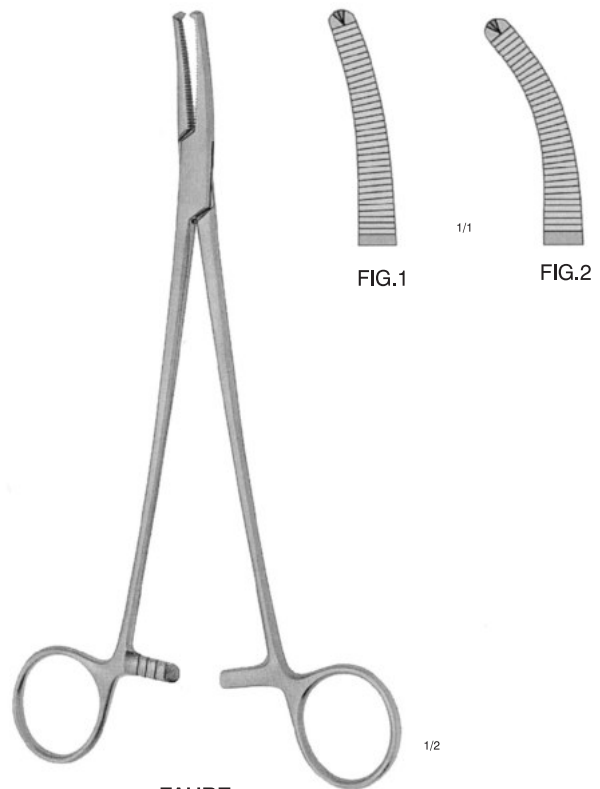

FAURE  
20.5cm, 8"  
1x2 teeth

043-0850	FIG.1
043-0860	FIG.2



**BECKMANN**  
22.0cm, 8 1/2"

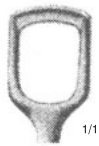

043-0901 | Straight  
043-0911 | Curved

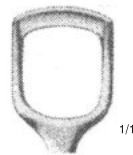

043-0902 | Straight  
043-0912 | Curved

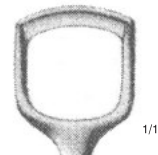

043-0903 | Straight  
043-0913 | Curved

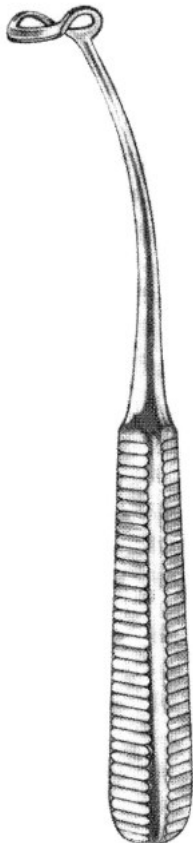

**BECKMANN**  
22.0cm, 8 1/2"

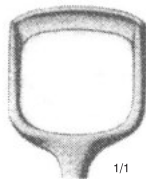

043-0904 | Straight  
043-0914 | Curved

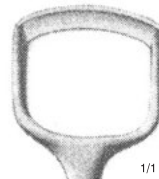

043-0905 | Straight  
043-0915 | Curved

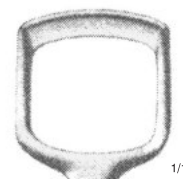

043-0906 | Straight  
043-0916 | Curved



**LA FORCE**  
Adenotomes  
22.0cm, 8 1/2"

Unperforated

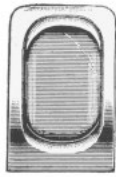

13mm

<b>043-1001</b>	13mm
<b>043-1002</b>	16mm
<b>043-1003</b>	19mm

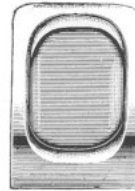

16mm

<b>043-1101</b>	13mm	Spare Blade only
<b>043-1102</b>	16mm	Spare Blade only
<b>043-1103</b>	19mm	Spare Blade only

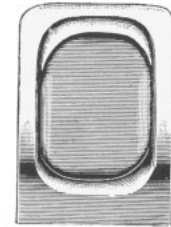

19mm

Perforated

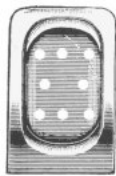

13mm

<b>043-1010</b>	13mm
<b>043-1020</b>	16mm
<b>043-1030</b>	19mm

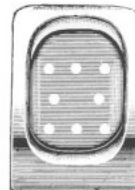

16mm

<b>043-1110</b>	13mm	Spare Blade only
<b>043-1120</b>	16mm	Spare Blade only
<b>043-1130</b>	19mm	Spare Blade only

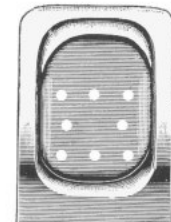

19mm

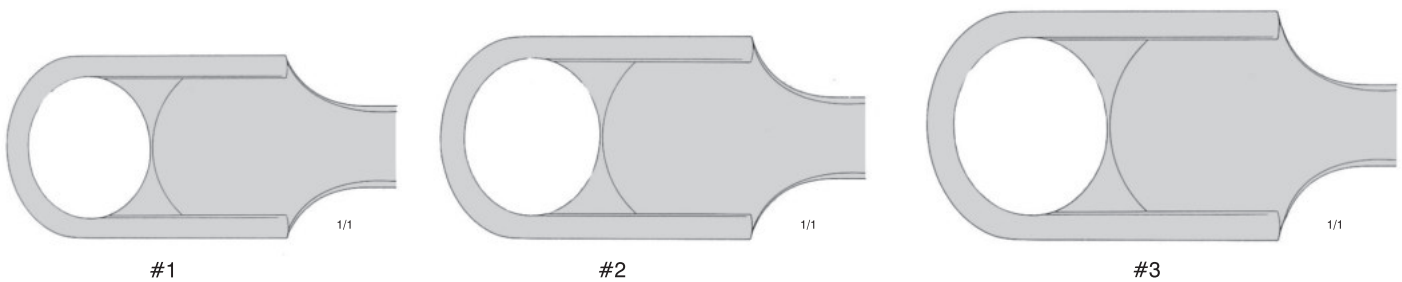

#1

#2

#3



<b>043-1201</b>	#1
<b>043-1202</b>	#2
<b>043-1203</b>	#3

**SLUDER-BALLENGER**  
Tonsillectomes

1/2

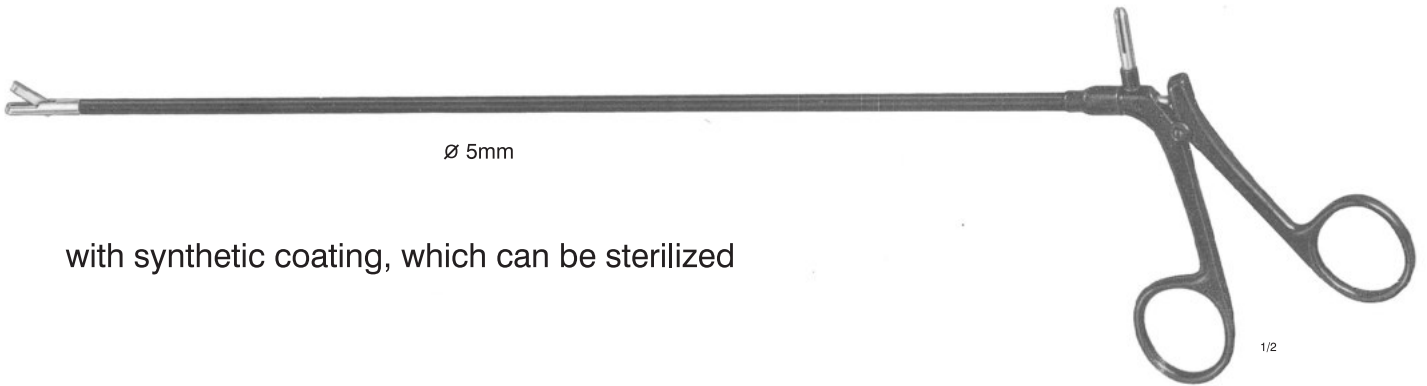

with synthetic coating, which can be sterilized

ENDOSCOPY

Fig.1



<b>043-1301</b>	30.0cm, 12"	Ø 5mm
<b>043-1310</b>	45.0cm, 17"	Ø 5mm

Fig.5



<b>043-1305</b>	30.0cm, 12"	Ø 5mm
<b>043-1350</b>	45.0cm, 17"	Ø 5mm

Fig.2



<b>043-1302</b>	30.0cm, 12"	Ø 5mm
<b>043-1320</b>	45.0cm, 17"	Ø 5mm

Fig.6



<b>043-1306</b>	30.0cm, 12"	Ø 5mm
<b>043-1360</b>	45.0cm, 17"	Ø 5mm

Fig.3



<b>043-1303</b>	30.0cm, 12"	Ø 5mm
<b>043-1330</b>	45.0cm, 17"	Ø 5mm

Fig.7



<b>043-1307</b>	30.0cm, 12"	Ø 5mm
<b>043-1370</b>	45.0cm, 17"	Ø 5mm

Fig.4



<b>043-1304</b>	30.0cm, 12"	Ø 5mm
<b>043-1340</b>	45.0cm, 17"	Ø 5mm

Fig.8



<b>043-1308</b>	30.0cm, 12"	Ø 5mm
<b>043-1380</b>	45.0cm, 17"	Ø 5mm



HUBER  
shank

043-1410	20.0cm, 8"
043-1420	30.0cm, 12"
043-1430	40.0cm, 16"



HUBER

043-1400 | Handle

Fig.1



KEVORKIAN

043-1401

Fig.2



TISCHLER

043-1402

Fig.4



043-1404

Fig.3



043-1403

Fig.5



ø 4mm

043-1405



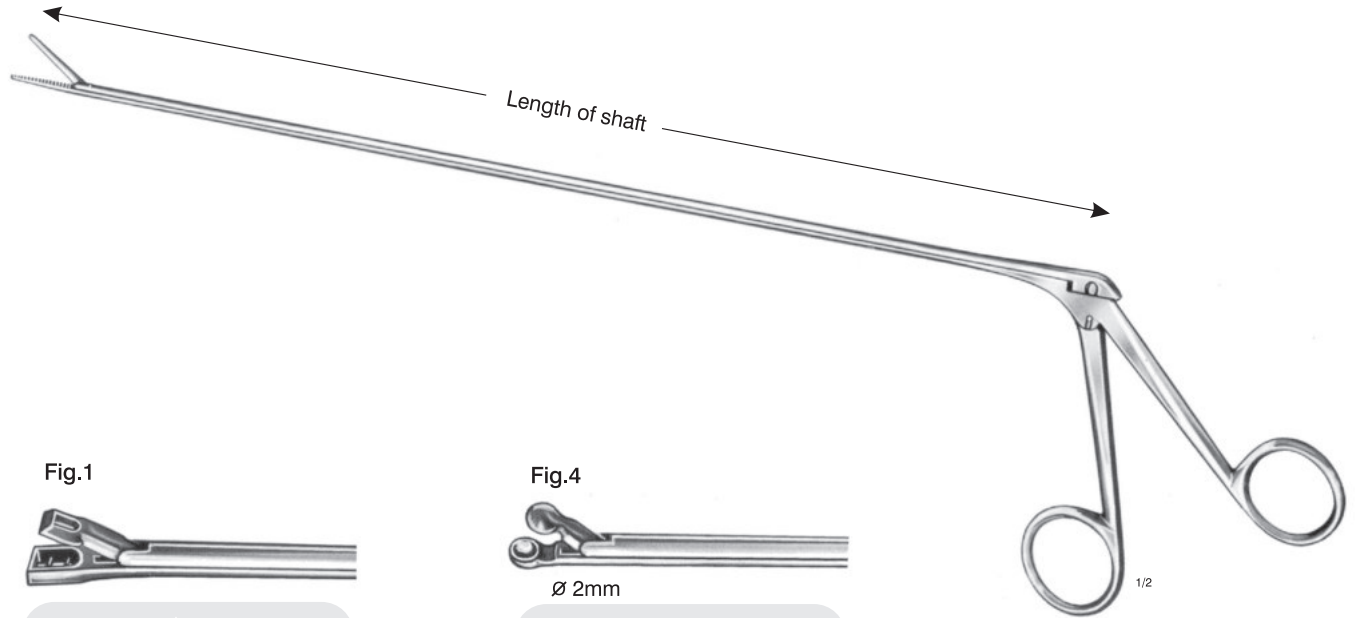

**CHEVALIER-JACKSON**

**Fig.1**



<b>043-1501</b>	30.0cm, 12"
<b>043-1502</b>	40.0cm, 15 7/10"
<b>043-1503</b>	50.0cm, 19 7/10"
<b>043-1504</b>	60.0cm, 23 3/5"

**Fig.4**



Ø 2mm

<b>043-1801</b>	30.0cm, 12"
<b>043-1802</b>	40.0cm, 15 7/10"
<b>043-1803</b>	50.0cm, 19 7/10"
<b>043-1804</b>	60.0cm, 23 3/5"

Ø 4mm

<b>043-1901</b>	30.0cm, 12"
<b>043-1902</b>	40.0cm, 15 7/10"
<b>043-1903</b>	50.0cm, 19 7/10"
<b>043-1904</b>	60.0cm, 23 3/5"

Ø 6mm

<b>043-2001</b>	30.0cm, 12"
<b>043-2002</b>	40.0cm, 15 7/10"
<b>043-2003</b>	50.0cm, 19 7/10"
<b>043-2004</b>	60.0cm, 23 3/5"

**Fig.5**



<b>043-2101</b>	30.0cm, 12"
<b>043-2102</b>	40.0cm, 15 7/10"
<b>043-2103</b>	50.0cm, 19 7/10"
<b>043-2104</b>	60.0cm, 23 3/5"

**Fig.6**



<b>043-2201</b>	30.0cm, 12"
<b>043-2202</b>	40.0cm, 15 7/10"
<b>043-2203</b>	50.0cm, 19 7/10"
<b>043-2204</b>	60.0cm, 23 3/5"

**Fig.7**



Ø 2mm

<b>043-1811</b>	30.0cm, 12"
<b>043-1812</b>	40.0cm, 15 7/10"
<b>043-1813</b>	50.0cm, 19 7/10"
<b>043-1814</b>	60.0cm, 23 3/5"

Ø 4mm

<b>043-1911</b>	30.0cm, 12"
<b>043-1912</b>	40.0cm, 15 7/10"
<b>043-1913</b>	50.0cm, 19 7/10"
<b>043-1914</b>	60.0cm, 23 3/5"

Ø 6mm

<b>043-2011</b>	30.0cm, 12"
<b>043-2012</b>	40.0cm, 15 7/10"
<b>043-2013</b>	50.0cm, 19 7/10"
<b>043-2014</b>	60.0cm, 23 3/5"

**Fig.8**

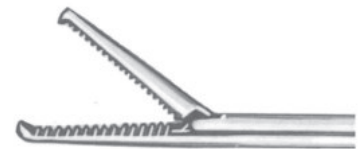

<b>043-2301</b>	30.0cm, 12"
<b>043-2302</b>	40.0cm, 15 7/10"
<b>043-2303</b>	50.0cm, 19 7/10"
<b>043-2304</b>	60.0cm, 23 3/5"



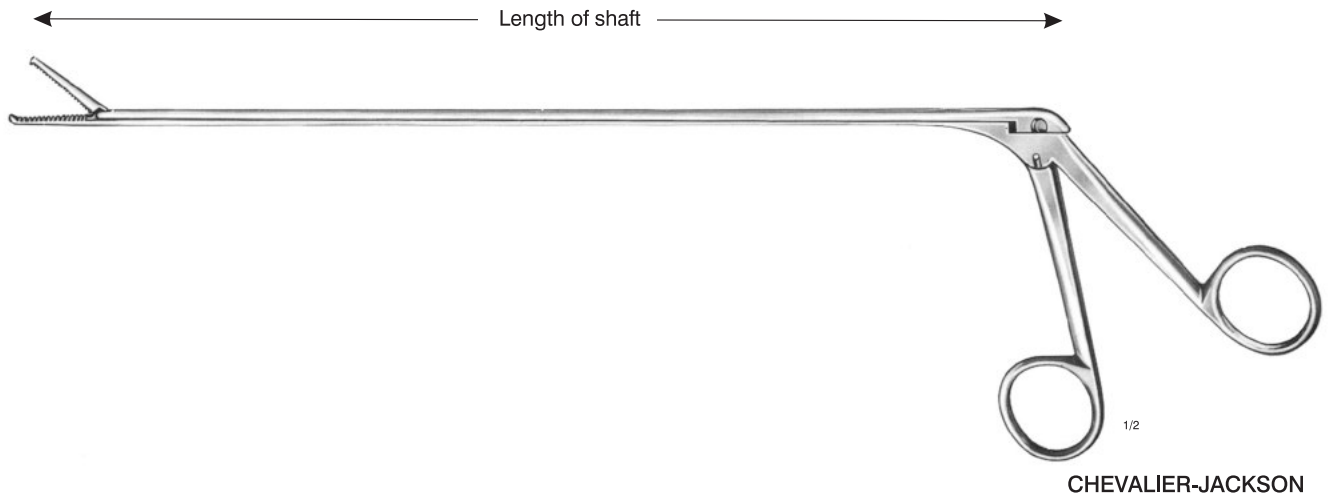
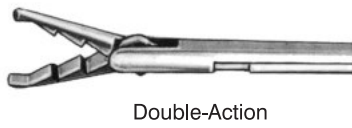
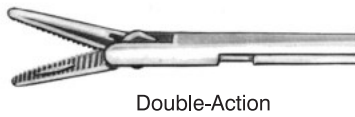

Fig.9



043-1721	30.0cm, 12"
043-1722	40.0cm, 15 7/10"
043-1723	50.0cm, 19 7/10"
043-1724	60.0cm, 23 3/5"

Fig.10



043-1621	30.0cm, 12"
043-1622	40.0cm, 15 7/10"
043-1623	50.0cm, 19 7/10"
043-1624	60.0cm, 23 3/5"

Fig.11

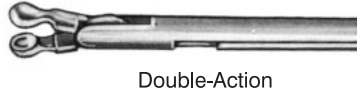

043-1821	30.0cm, 12"
043-1822	40.0cm, 15 7/10"
043-1823	50.0cm, 19 7/10"
043-1824	60.0cm, 23 3/5"



Fig.1



Fig.2



Fig.3

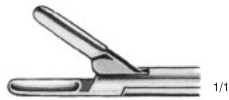
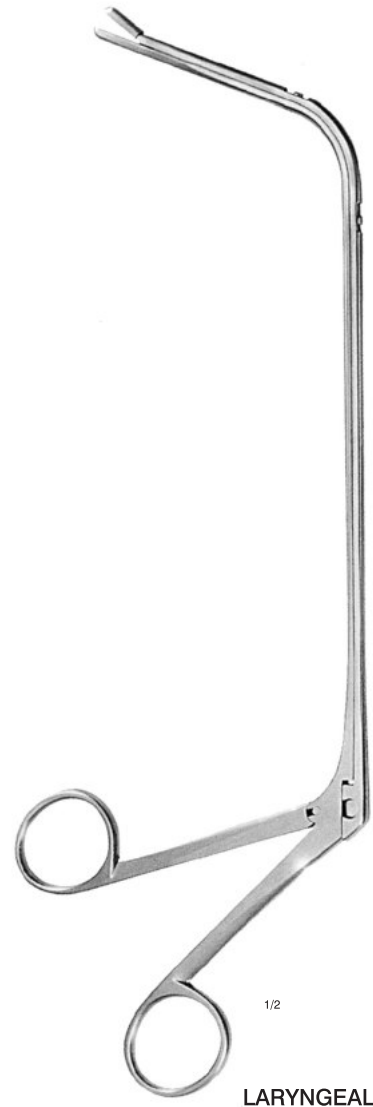

Fig.4

043-2401	FIG.1
043-2402	FIG.2
043-2403	FIG.3
043-2404	FIG.4



LARYNGEAL



THYROID LIFT

► 043-2500